

# MAXSYS®

---

## PC4020 v3.3 (US, UL) • Installation Manual

DLS-3 v1.3

**WARNING:** *This manual contains information on limitations regarding product use and function and information on the limitations as to liability of the manufacturer. The entire manual should be carefully read.*

## **WARNING Please Read Carefully**

### **Note to Installers**

This warning contains vital information. As the only individual in contact with system users, it is your responsibility to bring each item in this warning to the attention of the users of this system.

### **System Failures**

This system has been carefully designed to be as effective as possible. There are circumstances, however, involving fire, burglary, or other types of emergencies where it may not provide protection. Any alarm system of any type may be compromised deliberately or may fail to operate as expected for a variety of reasons. Some but not all of these reasons may be:

#### **■ Inadequate Installation**

A security system must be installed properly in order to provide adequate protection. Every installation should be evaluated by a security professional to ensure that all access points and areas are covered. Locks and latches on windows and doors must be secure and operate as intended. Windows, doors, walls, ceilings and other building materials must be of sufficient strength and construction to provide the level of protection expected. A reevaluation must be done during and after any construction activity. An evaluation by the fire and/or police department is highly recommended if this service is available.

#### **■ Criminal Knowledge**

This system contains security features which were known to be effective at the time of manufacture. It is possible for persons with criminal intent to develop techniques which reduce the effectiveness of these features. It is important that a security system be reviewed periodically to ensure that its features remain effective and that it be updated or replaced if it is found that it does not provide the protection expected.

#### **■ Access by Intruders**

Intruders may enter through an unprotected access point, circumvent a sensing device, evade detection by moving through an area of insufficient coverage, disconnect a warning device, or interfere with or prevent the proper operation of the system.

#### **■ Power Failure**

Control units, intrusion detectors, smoke detectors and many other security devices require an adequate power supply for proper operation. If a device operates from batteries, it is possible for the batteries to fail. Even if the batteries have not failed, they must be charged, in good condition and installed correctly. If a device operates only by AC power, any interruption, however brief, will render that device inoperative while it does not have power. Power interruptions of any length are often accompanied by voltage fluctuations which may damage electronic equipment such as a security system. After a power interruption has occurred, immediately conduct a complete system test to ensure that the system operates as intended.

#### **■ Failure of Replaceable Batteries**

This system's wireless transmitters have been designed to provide several years of battery life under normal conditions. The expected battery life is a function of the device environment, usage and type. Ambient conditions such as high humidity, high/low temperatures, or large temperature fluctuations may reduce the expected battery life. While each transmitting device has a low battery monitor which identifies when the batteries need to be replaced, this monitor may fail to operate as expected. Regular testing and maintenance will keep the system in good operating condition.

#### **■ Compromise of Radio Frequency (Wireless) Devices**

Signals may not reach the receiver under all circumstances which could include metal objects placed on or near the radio path or deliberate jamming or other inadvertent radio signal interference.

#### **■ System Users**

A user may not be able to operate a panic or emergency switch possibly due to permanent or temporary physical disability, inability to reach the device in time, or unfamiliarity with the correct operation. It is important that all system users be trained in the correct operation of the alarm system and that they know how to respond when the system indicates an alarm.

#### **■ Smoke Detectors**

Smoke detectors that are a part of this system may not properly alert occupants of a fire for a number of reasons, some of which follow. The smoke detectors may have been improperly installed or positioned. Smoke may not be able to reach the smoke detectors, such as when the fire is in a chimney, walls or roofs, or on the other side of closed doors. Smoke detectors may not detect smoke from fires on another level of the residence or building.

Every fire is different in the amount of smoke produced and the rate of burning. Smoke detectors cannot sense all types of fires equally well. Smoke detectors may not provide timely warning of fires caused by carelessness or safety hazards such as smoking in bed, violent explosions, escaping gas, improper storage of flammable materials, overloaded electrical circuits, children playing with matches or arson. Even if the smoke detector operates as intended, there may be circumstances when there is insufficient warning to allow all occupants to escape in time to avoid injury or death.

#### **■ Motion Detectors**

Motion detectors can only detect motion within the designated areas as shown in their respective installation instructions. They cannot discriminate between intruders and intended occupants. Motion detectors do not provide volumetric area protection. They have multiple beams of detection and motion can only be detected in unobstructed areas covered by these beams. They cannot detect motion which occurs behind walls, ceilings, floor, closed doors, glass partitions, glass doors or windows. Any type of tampering whether intentional or unintentional such as masking, painting, or spraying of any material on the lenses, mirrors, windows or any other part of the detection system will impair its proper operation.

Passive infrared motion detectors operate by sensing changes in temperature. However their effectiveness can be reduced when the ambient temperature rises near or above body temperature or if there are intentional or unintentional sources of heat in or near the detection area. Some of these heat sources could be heaters, radiators, stoves, barbecues, fireplaces, sunlight, steam vents, lighting and so on.

#### **■ Warning Devices**

Warning devices such as sirens, bells, horns, or strobes may not warn people or waken someone sleeping if there is an intervening wall or door. If warning devices are located on a different level of the residence or premise, then it is less likely that the occupants will be alerted or awakened. Audible warning devices may be interfered with by other noise sources such as stereos, radios, televisions, air conditioners or other appliances, or passing traffic. Audible warning devices, however loud, may not be heard by a hearing-impaired person.

#### **■ Telephone Lines**

If telephone lines are used to transmit alarms, they may be out of service or busy for certain periods of time. Also an intruder may cut the telephone line or defeat its operation by more sophisticated means which may be difficult to detect.

#### **■ Insufficient Time**

There may be circumstances when the system will operate as intended, yet the occupants will not be protected from the emergency due to their inability to respond to the warnings in a timely manner. If the system is monitored, the response may not occur in time to protect the occupants or their belongings.

#### **■ Component Failure**

Although every effort has been made to make this system as reliable as possible, the system may fail to function as intended due to the failure of a component.

#### **■ Inadequate Testing**

Most problems that would prevent an alarm system from operating as intended can be found by regular testing and maintenance. The complete system should be tested weekly and immediately after a break-in, an attempted break-in, a fire, a storm, an earthquake, an accident, or any kind of construction activity inside or outside the premises. The testing should include all sensing devices, keypads, consoles, alarm indicating devices and any other operational devices that are part of the system.

#### **■ Security and Insurance**

Regardless of its capabilities, an alarm system is not a substitute for property or life insurance. An alarm system also is not a substitute for property owners, renters, or other occupants to act prudently to prevent or minimize the harmful effects of an emergency situation.

## **Limited Warranty**

Digital Security Controls Ltd. warrants the original purchaser that for a period of twelve months from the date of purchase, the product shall be free of defects in materials and workmanship under normal use. During the warranty period, Digital Security Controls Ltd. shall, at its option, repair or replace any defective product upon return of the product to its factory, at no charge for labour and materials. Any replacement and/or repaired parts are warranted for the remainder of the original warranty or ninety (90) days, whichever is longer. The original purchaser must promptly notify Digital Security Controls Ltd. in writing that there is defect in material or workmanship, such written notice to be received in all events prior to expiration of the warranty period. There is absolutely no warranty on software and all software products are sold as a user license under the terms of the software license agreement included with the product. The Customer assumes all responsibility for the proper selection, installation, operation and maintenance of any products purchased from DSC. Custom products are only warranted to the extent that they do not function upon delivery. In such cases, DSC can replace or credit at its option.

#### **International Warranty**

The warranty for international customers is the same as for any customer within Canada and the United States, with the exception that Digital Security Controls Ltd. shall not be responsible for any customs fees, taxes, or VAT that may be due.

#### **Warranty Procedure**

To obtain service under this warranty, please return the item(s) in question to the point of purchase. All authorized distributors and dealers have a warranty program. Anyone returning goods to Digital Security Controls Ltd. must first obtain an authorization number. Digital Security Controls Ltd. will not accept any shipment whatsoever for which prior authorization has not been obtained.

#### **Conditions to Void Warranty**

This warranty applies only to defects in parts and workmanship relating to normal use. It does not cover:

- damage incurred in shipping or handling;
- damage caused by disaster such as fire, flood, wind, earthquake or lightning;
- damage due to causes beyond the control of Digital Security Controls Ltd. such as excessive voltage, mechanical shock or water damage;
- damage caused by unauthorized attachment, alterations, modifications or foreign objects;
- damage caused by peripherals (unless such peripherals were supplied by Digital Security Controls Ltd.);
- defects caused by failure to provide a suitable installation environment for the products;
- damage caused by use of the products for purposes other than those for which it was designed;
- damage from improper maintenance;
- damage arising out of any other abuse, mishandling or improper application of the products.

#### **Items Not Covered by Warranty**

In addition to the items which void the Warranty, the following items shall not be covered by Warranty: (i) freight cost to the repair centre; (ii) products which are not identified with DSC's product label and lot number or serial number; (iii) products disassembled or repaired in such a manner as to adversely affect performance or prevent adequate inspection or testing to verify any warranty claim. Access cards or tags returned for replacement under warranty will be credited or replaced at DSC's option. Products not covered by this warranty, or otherwise out of warranty due to age, misuse, or damage shall be evaluated, and a repair estimate shall be provided. No repair work will be performed until a valid purchase order is received from the Customer and a Return Merchandise Authorisation number (RMA) is issued by DSC's Customer Service.

Digital Security Controls Ltd.'s liability for failure to repair the product under this warranty after a reasonable number of attempts will be limited to a replacement of the product, as the exclusive remedy for breach of warranty. Under no circumstances shall Digital Security Controls Ltd. be liable for any special, incidental, or consequential damages based upon breach of warranty, breach of contract, negligence, strict liability, or any other legal theory. Such damages include, but are not limited to, loss of profits, loss of the product or any associated equipment, cost of capital, cost of substitute or replacement equipment, facilities or services, down time, purchaser's time, the claims of third parties, including customers, and injury to property. The laws of some jurisdictions limit or do not allow the disclaimer of consequential damages. If the laws of such a jurisdiction apply to any claim by or against DSC, the limitations and disclaimers contained here shall be to the greatest extent permitted by law. Some states do not allow the exclusion or limitation of incidental or consequential damages, so that the above may not apply to you.

#### **Disclaimer of Warranties**

This warranty contains the entire warranty and shall be in lieu of any and all other warranties, whether expressed or implied (including all implied warranties of merchantability or fitness for a particular purpose) and of all other obligations or liabilities on the part of Digital Security Controls Ltd. Digital Security Controls Ltd. neither assumes responsibility for, nor authorizes any other person purporting to act on its behalf to modify or to change this warranty, nor to assume for it any other warranty or liability concerning this product. This disclaimer of warranties and limited warranty are governed by the laws of the province of Ontario, Canada.

**WARNING: Digital Security Controls Ltd. recommends that the entire system be completely tested on a regular basis. However, despite frequent testing, and due to, but not limited to, criminal tampering or electrical disruption, it is possible for this product to fail to perform as expected.**

#### **Out of Warranty Repairs**

Digital Security Controls Ltd. will at its option repair or replace out-of-warranty products which are returned to its factory according to the following conditions. Anyone returning goods to Digital Security Controls Ltd. must first obtain an authorization number. Digital Security Controls Ltd. will not accept any shipment whatsoever for which prior authorization has not been obtained.

Products which Digital Security Controls Ltd. determines to be repairable will be repaired and returned. A set fee which Digital Security Controls Ltd. has predetermined and which may be revised from time to time, will be charged for each unit repaired.

Products which Digital Security Controls Ltd. determines not to be repairable will be replaced by the nearest equivalent product available at that time. The current market price of the replacement product will be charged for each replacement unit.

# Table of Contents

---

<b>Section 1: Introduction</b>	<b>1</b>	<b>Section 8: Arming and Disarming</b>	<b>27</b>
1.1 Out of the Box .....	1	8.1 Arming and Disarming Options .....	27
1.2 Specifications and Features .....	1	8.2 Automatic Arming .....	27
<b>Section 2: Installation and Wiring</b>	<b>2</b>	<b>Section 9: Entry and Exit Delay</b>	<b>28</b>
2.1 Planning the System .....	2	9.1 Entry and Exit Delay Times .....	28
2.2 Terminal Descriptions .....	2	9.2 Entry and Exit Delay Options .....	28
2.3 Wire Routing for Power and Non-Power Limited .....	2	<b>Section 10: System Programming</b>	<b>29</b>
2.4 Current Ratings – Alarm Control Panel and Modules .....	2	10.1 AC/DC Power Options .....	29
2.5 Combustion Operation and Wiring .....	3	10.2 Bell Circuit Supervision .....	29
2.6 Zone Wiring .....	4	10.3 Clock Options .....	29
2.7 Specialized Zone Wiring .....	5	10.4 Event Messages .....	30
2.8 Programmable Output Wiring .....	5	10.5 Swinger Shutdown .....	30
2.9 AML Device Wiring .....	5	10.6 Tamper .....	30
2.10 Wiring Powered Devices (AUX, SAUX+) .....	6	10.7 Telephone Line Supervision .....	31
2.11 Telephone Line Wiring .....	7	10.8 Test Transmissions .....	31
2.12 Bell Output Wiring (BELL+ and BELL-) .....	7	10.9 Transmission Delay .....	31
2.13 Earth Ground Wiring .....	7	10.10 Cross Zone (Police Code) Alarm .....	32
2.14 Applying Power (AC and Battery) .....	7	10.11 System Label .....	32
2.15 Lithium Batteries .....	8	10.12 Hourly Print .....	32
<b>Section 3: How to Program</b>	<b>9</b>	<b>Section 11: Programmable Outputs</b>	<b>33</b>
3.1 Introduction to Programming .....	9	11.1 Main Panel Outputs .....	33
3.2 Programming by Reference Number .....	9	11.2 Programming Output Options for Modules .....	33
3.3 Programming Decimal Data .....	9	11.3 Programmable Output Options .....	33
3.4 Programming Hexadecimal Data .....	10	11.4 Output Pulse Times .....	35
3.5 Programming Toggle Options .....	10	<b>Section 12: Communications Programming</b>	<b>37</b>
<b>Section 4: Module Enrollment</b>	<b>11</b>	12.1 Telephone Numbers .....	37
4.1 Enrolling Keypads and Modules .....	11	12.2 Account Numbers .....	37
4.2 Deleting Modules .....	11	12.3 Dialing Parameters .....	37
4.3 Confirming Modules .....	12	12.4 Communicator Toggle Options .....	37
4.4 Enrolling AML Devices .....	12	12.5 Dialer Direction .....	39
<b>Section 5: Partitions and Zones</b>	<b>13</b>	12.6 Communicator Formats .....	39
5.1 Zone Supervision .....	13	12.7 Reporting Codes .....	40
5.2 Creating Partitions .....	13	<b>Section 13: Downloading</b>	<b>41</b>
5.3 Adding Zones to Partitions .....	14	13.1 Downloading Options .....	41
5.4 Zone Programming .....	14	13.2 Periodic Call-up .....	41
<b>Section 6: Keypad Operation</b>	<b>18</b>	13.3 PC-Link .....	41
6.1 Partition Keypads .....	18	<b>Section 14: Event Scheduling</b>	<b>42</b>
6.2 Global Keypads .....	18	14.1 Date Schedules .....	42
6.3 Keypad Toggle Options .....	18	14.2 Holiday Groups .....	42
6.4 Keypad Time-out .....	19	14.3 Open/Close Suppression .....	42
6.5 Keypad Blanking .....	19	14.4 Arming/Disarming Schedules .....	43
6.6 Fire, Auxiliary and Panic Keys .....	19	14.5 Scheduled AMS-220/220T Smoke Detector Test .....	43
6.7 Keypad Lockout .....	19	<b>Section 15: LINKS Communications</b>	<b>44</b>
6.8 Keypad Tamper .....	20	15.1 LINKS1000 (Cellular Communications) .....	44
6.9 Alarm Memory Display .....	20	15.2 LINKS2XXX (Long-range Radio Communications) .....	44
6.10 Zone Bypass Display .....	20	15.3 T-Link TCP/IP Communications) .....	44
6.11 Function Key Programming .....	20	<b>Section 16: Diagnostics and Troubleshooting</b>	<b>45</b>
<b>Section 7: Installer and Access Codes</b>	<b>22</b>	16.1 General Diagnostics .....	45
7.1 Installer's Code .....	22	16.2 Restoring Factory Default Programming .....	45
7.2 Installer-Programmed Access Codes .....	22	16.3 Hardware Reset .....	45
7.3 Programming Access Codes .....	22	16.4 Viewing Trouble Conditions .....	45
7.4 Modify An Existing Code .....	24	16.5 System Fault Squawk .....	46
7.5 Change User Code Options .....	24	<b>• Appendix A: Reporting Codes</b>	<b>48</b>
7.6 Delete An Existing Code .....	25	<b>• Appendix B: Zone Reporting Codes</b>	<b>51</b>
7.7 Special Codes .....	25	<b>• Appendix C: ASCII Characters</b>	<b>52</b>
7.8 Guard Code .....	26		
7.9 Access Code Options .....	26		
7.10 Access Levels .....	26		

# PC4020 Wiring Diagram

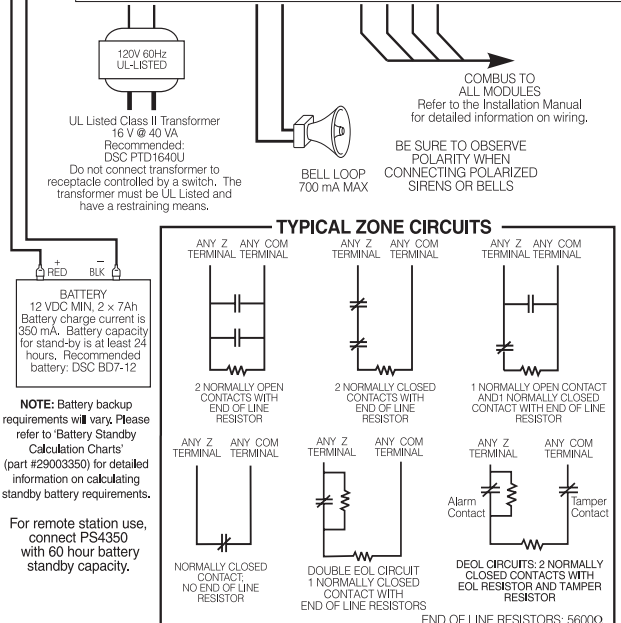
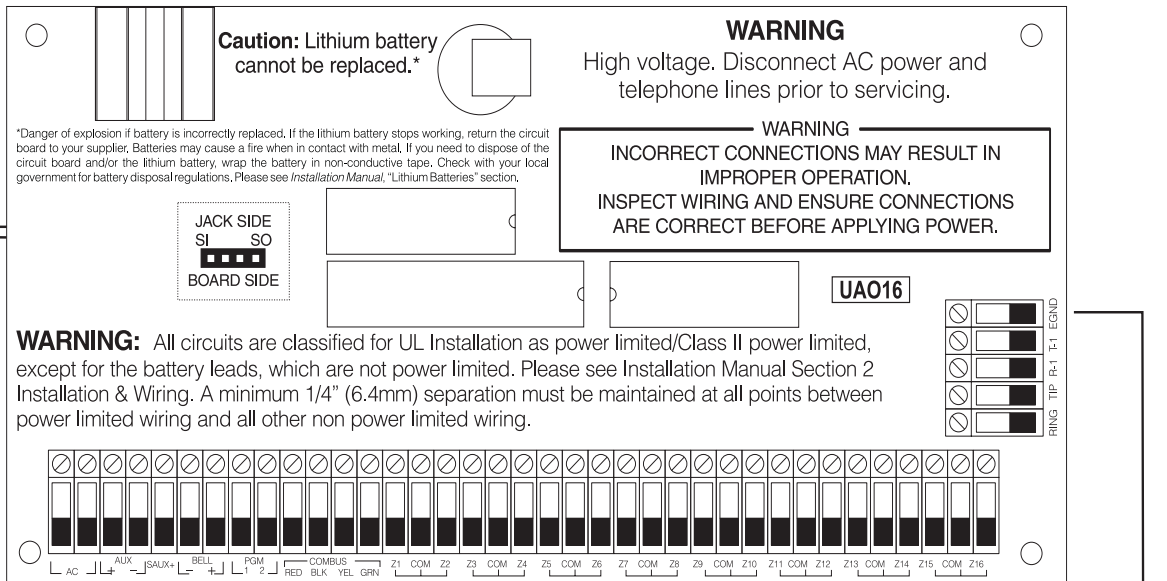

**NOTE:** Battery backup requirements will vary. Please refer to 'Battery Standby Calculation Charts' (part #29003350) for detailed information on calculating standby battery requirements.

For remote station use, connect PS4350 with 60 hour battery standby capacity.

**WARNING:** Not to be removed by anyone except occupant. This equipment should be installed in accordance with ANSI/NFPA 72 (National Fire Protection Association, Batterymarch Park, Quincy MA, 02269). Printed information describing proper installation, operation, testing, maintenance, evacuation planning, and repair service is to be provided with this equipment.

**WARNING:** This unit includes an alarm verification feature that will result in a delay of the system alarm signal from the indicated circuits. The total delay (control unit plus smoke detectors) shall not exceed 60 seconds. No other smoke detector shall be connected to these circuits unless approved by the local authority having jurisdiction.

Refer to the Installation and Instruction Manuals for complete operating instructions.

The PC4020 Custom Series is UL Listed for limited energy installations per NEC Article 760. Recognized limited energy cable should be used. Observe NEC wiring requirements and local codes defined by the authority having jurisdiction.

This equipment should be installed in accordance with NFPA 72 (National Fire Protection Association, Batterymarch Park, Quincy MA, 02269). Printed information describing proper installation, operation, testing, maintenance, evacuation planning, and repair service is to be provided with this equipment.

Security detection devices that require power from the control panel must be UL Listed for the intended application and operate over the range of 10.0 to 14.0 Vdc. The DSC Bravo Series is a recommended UL Listed motion detector.

Temperature Range: 0°C to 49°C (32°F to 120°F)

Maximum Humidity: 85% relative humidity

Control Panel is suitable for the following UL installations:

- Grade AA Central Station and Grade AA Police Connect with high line security (using T-Link to communicate to Sur-Gard MLR-IP receiver)
- Household Fire and Grade A Household Burglary
- Grade A Local
- Grade B Central Station and Grade A Police Connect with basic line security
- Grade C Central Station and Grade A Police Connect with basic line security

Refer to Installation Manual #29005774

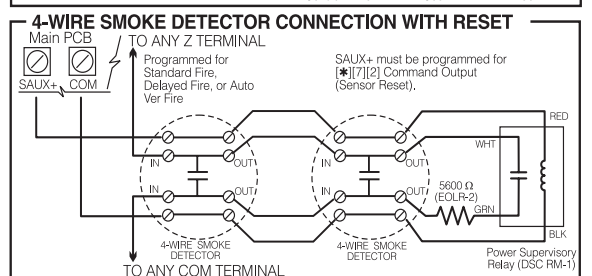
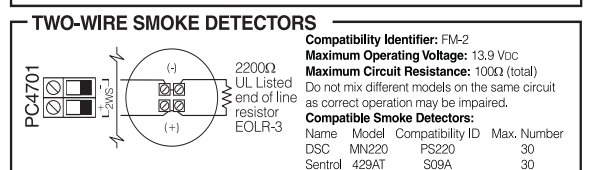
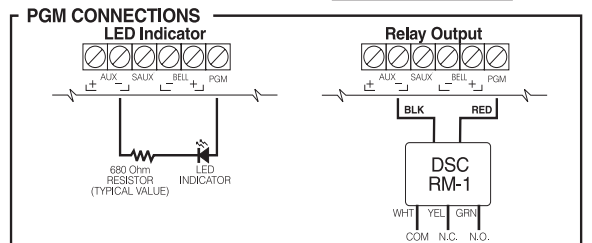
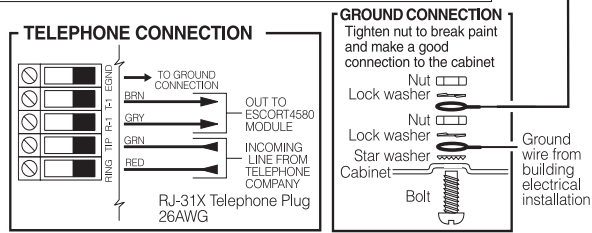

This device complies with Parts 15 and 68 of the FCC rules. Operation is subject to the following two conditions: (1) this device may not cause harmful interference, and (2) this device must accept any interference received, including interference that may cause undesired operation.

FCC Reg. No.: F53CAN-20836-AL-E REN = 0,1B Plug Type : RJ-31X MADE IN CANADA

Circuit (zone)	Control Unit Delay - Sec.	Smoke Detector	
		Model	Delay - Sec. (a)

(a) The delay (power-up) (start-up) time marked on the installation wiring diagram of the smoke detector or on the installed smoke detector(s) is to be used.

**NOTE:** Do not remove the foam from the back of the circuit board.

# Section 1: Introduction

---

## 1.1 Out Of The Box

Please verify that the following components are included in the PC4020 package.

- 1 PC4050C or PC4001C cabinet
- 1 Version 3.3 main control module
- 1 Hardware package which includes:
  - 32 EOL resistors (5600Ω)
  - 1 Black cabinet plug
  - 1 Green ground strap
  - PCB mounting standoffs
- 1 set of documents which includes:
  - 1 Installation Manual
  - 1 Programming Worksheets
  - 1 Instruction Manual

## 1.2 Specifications and Features

### Main Control Panel

- AC Input – 16 VAC, 40VA minimum
- Battery Charger – 350 mA to charge 12VDC lead-acid batteries
- Bell Circuit – 12 VDC, 700 mA continuous maximum
- Auxiliary Power Output: 12 VDC, 500 mA maximum
- Switched Auxiliary Power Output 12 VDC, 300 mA maximum
- PGM 1 & 2 – two options:
  - 12 VDC, 50 mA maximum each as standard outputs
  - 12 VDC, 170 mA maximum each when used for addressable loop
- 4-wire Combus power – 500 mA maximum
- 16 Zone inputs
- Supervised dialer output
- Earth ground connection
- All outputs rated to operate over the range of 11.6 to 12.6V for UL Listed systems.

### Expansion Capabilities

- Up to 128 zones total using
  - PC4108A 8-zone input modules
  - PC4116 16-zone input modules
  - PC4164 v2.x wireless receivers and wireless devices
  - PGM outputs for addressable devices
- Up to 16 keypads total using
  - LCD4501 keypad (with function keys) - v2.0 or later
  - LCD4500 keypad - v2.02 for function key support (number keys 1-5)
- Up to 144 low power outputs total using
  - PC4216 low power output modules (v2.1 required for Temporal Fire option)
- Up to 64 relay outputs total using
  - PC4204 quad relay and power supply module; also for Combus repower (v2.1 required for Temporal Fire option)
  - PC4204CX Combus repeater

- Up to 8 supervised bell outputs total using
  - PC4702BP (up to 4)
- Up to 32 card access-controlled doors
  - PC4820 dual card reader modules (up to 16)
- System Printer/DVACS\* output using
  - DataLink\*\*
  - PC440X module
- Dual phone line and Class 'B' fire zones using
  - PC4701 fire module
- Backup communication using
  - LINKS1000 cellular communicator
  - LINKS2150 long-range transmitter
  - LINKS2450 long-range transmitter\*\*
  - Any compatible alternate communication module\*\*
  - T-Link TCP/IP Ethernet Communicator (see the T-Link Installation Manual part no. 29001007)
  - Skyroute Max
- Telephone access & automation items using
  - ESCORT4580 Audio Assistant (v1.3 or greater)
- Remote annunciation using
  - PC4612 – 12-zone point annunciator
  - PC4632 – 32-zone point/graphic annunciator
  - PC4664 – 64-zone point/graphic annunciator
- Central station talk/listen\*\* and intercom capabilities using:
  - PC4936 audio interface module
  - PC4937 8-port expansion module
  - LCD4501/4500 keypad and audio station
  - PC5921 audio stations
- Up to 32 telephone entry doors
  - PC4850 module (up to 16)\*\*

### Downloading Capabilities

- Downloading Software: DLS-3 v1.3\*\*
- PC-Link connector – for local upload/download
- End user PC-Link using PC4401 as isolator\*\*
- DataLink access using PC4401
- T-Link TCP/IP module

\* DVACS is a registered trademark of Electro Arts Limited

\*\* Not UL Listed. Do not use in conjunction with UL Listed systems.

# Section 2: Installation and Wiring

## 2.1 Planning the System

The speed and efficiency of installing a MAXSYS system will be greatly enhanced by planning the installation. As a minimum, the following checklist should be used to ensure that all of the details have been considered:

- ❑ Draw a diagram of the installation showing the location of the main panel, all keypads, zone inputs, bell outputs, relay outputs and annunciators.
- ❑ Indicate all partitions on the diagram. Decide which zones, bell and relay outputs, keypads and remote annunciators belong to each partition.
- ❑ Determine where each system module is going to be located and how far each module will be from the main panel.
- ❑ Determine the current draw on the main panel and each system component used to ensure the system requirements can be met (see 2.4 'Current Ratings – Alarm Control Panel and Modules'). Calculate each wire run using the Combus wiring guidelines. Determine which wire gauge should be used and where to place PC4204/PC4204CX modules to re-power the Combus.
- ❑ For Addressable devices, determine where each device is to be located and consult the Addressable Loop wiring guidelines to determine wire gauge and wiring lengths (see 2.9 'AML Device Wiring')

## 2.2 Terminal Descriptions

The following terminals appear on the alarm control panel:

Terminals	Description
Red and Black Leads	Battery Connection. <b>WARNING: Do not connect the battery or transformer until all other wiring is complete.</b>
AC	Power Terminals. <b>WARNING: Connect the battery before connecting the AC. Do not connect the battery or transformer until all other wiring is complete.</b>
AUX+ and AUX-	Auxiliary Power, 500mA MAX
SAUX+	Switched Auxiliary Power, 300mA MAX
BELL+ and BELL-	Bell/Siren Power. These terminals are used for powering bells, sirens or other devices requiring steady output voltage on alarm; 700mA MAX
PGM1 and PGM2	Programmable Output Terminals. 50mA MAX (standard output) or 170mA MAX (addressable loop)
RED, BLK, YEL, GRN	Combus Terminals. The Combus is used by the panel and the modules to communicate with each other. RED and BLK are used for power, and YEL and GRN for data. <b>NOTE: The four Combus terminals of the main panel must be connected to the four Combus terminals or wires of all modules. For instructions regarding Combus wiring, refer to Section 2.4 'Combus Operation and Wiring'.</b>
Z1 to Z16	Zone Input Terminals. Zone inputs Z1 to Z16 are provided for wiring zones on the alarm control panel

Terminals	Description
TIP, RING, T1, R1	Telephone Line Terminals
EGND	Earth Ground Connection. A ground connection assembly is included with the control panel. Please refer to the control panel wiring diagram for ground connection instructions.

## 2.3 Wire Routing for Power and Non-Power Limited

All wiring entry points are designated by the arrows. All circuits are classified UL installation power limited except for the battery leads which are not power limited.

A minimum 1/4" (7mm) separation must be maintained at all points between power limited and non-power limited wiring and connections.

**NOTE:** Wire entry for power limited wiring must be separated by a different entry access from non-power limited wiring.

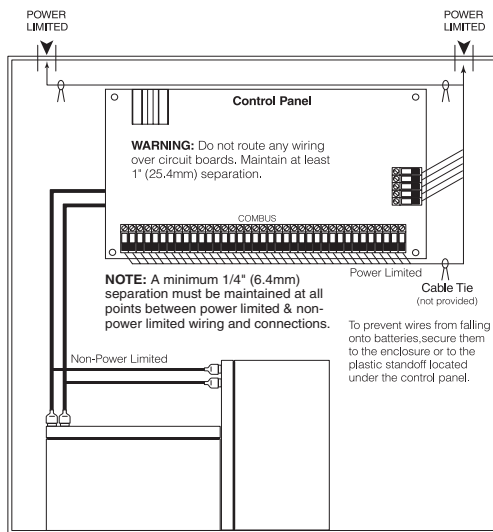

## 2.4 Current Ratings – Alarm Control Panel and Modules

In order for the system to operate properly, the power output of the alarm control panel and power supply modules cannot be exceeded. Use the data below to ensure that the available current is not exceeded.

### Alarm Control Panel

**AUX** - 500mA available for devices connected to the AUX, SAUX+ and PGM terminals and modules connected to Combus terminals. At least 100mA must be reserved for the Combus. To calculate the amount of current required, complete the following chart:

### Main Panel Current Calculation Maximum (Standby or Alarm)

AUX (500mA max.)

SAUX+ (300mA max.)

PGM1 (50/170mA max.\*)

PGM2 (50/170mA max.\*)

Combus (500mA max.)\*\*

Total (must not exceed 500mA)

\*PGM1/PGM2 (Standard Output) = 50mA max.

**NOTE:** PGM1/PGM2 (Addressable Loop) = 170mA max.

**NOTE:** To calculate Addressable Loop current, see 2.9 'AML Device Wiring'.

\*\*See 'Combus Current Calculation Chart' below.

**NOTE:** For UL Listed applications, the total standby and alarm current cannot exceed 900mA.

**Module Ratings**

The current draw of compatible modules is listed below:

Device .....	Current Draw (mA)
Keypad .....	50
PC4108A Zone Expander .....	30
PC4116 Zone Expander .....	30
PC4164 Wireless Receiver .....	110
PC4701 Fire Module .....	35
PC4702BP Dual Bell Output Module .....	75
PC4204 Relay Output Module .....	30
PC4204CX Combus Repeater .....	30
PC4216 Low Current Output Module .....	15
ESCORT4580 Audio Assistant .....	150
PC4401 Interface Module .....	35
PC4820 Access Control Module .....	35
PC4936 Audio Interface Module .....	65
PC4850 Module .....	135

**Calculating Total Current Requirement**

Once you have determined which modules will draw power from the main panel, use the following chart to calculate the Combus current.

**Combus Current Selection Chart**

Item	Current (mA)	x	Quantity	Total (mA)
Keypad	50	x		
PC4108A*	30	x		
Current required for connected devices =				
PC4116*	30	x		
Current required for connected devices =				
PC4164	110	x		
PC4701	35			
PC4702BP	75	x		
PC4204/PC4204CX	30	x		
PC4216*	15	x		
Current required for connected devices =				
ESCORT4580	150			
PC4401	35	x		
PC4820	35	x		
<b>Total Combus Current =</b>				

**Combus Current Selection Chart**

Item	Current (mA)	x	Quantity	Total (mA)
PC4850	135	x		
PC4936*	65			
T-Link	150			
Skyroute	30			
<b>Total Combus Current =</b>				

**NOTE:** \*These units draw current from the Combus to power devices external to the module. This current must be added to the total Combus current. See manufacturer's specifications for the current draw of each device. Each LED assembly draws up to 20mA of current.

**2.5 Combus Operation and Wiring**

The Combus is used by the control panel and the modules to communicate with each other. The four Combus terminals of the main panel must be connected to the four Combus terminals or wires of all modules.

Modules can be home run, connected in a daisy chain or T-tapped anywhere on the Combus.

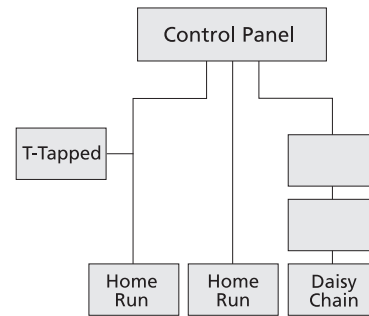

The following rules MUST be followed when wiring the Combus:

1. The Combus must be run in minimum 22-gauge wire.
2. No module can be more than **1000' (305m)** in cable length from the main control panel.
3. Shielded wire should only be used in areas that present excessive RF noise or electromagnetic interference. If shielded wire is used, the maximum distance a module can be located from the main panel is significantly reduced. Check the capacitance limit of the wire to calculate the maximum distance (see 'Capacitance Limits' below).
4. The total capacitance of the Combus wiring must not exceed 80nF (see 'Capacitance Limits' below).
5. Do not run Combus wire runs in parallel with AML wire runs. Maintain minimum 2" separation between the cables.

**Line Loss**

When current is drawn through a piece of wire, voltage will be lost due to the wire's resistance. This voltage loss must be considered for all installations.

To ensure proper operation, at least 12.5VDC must be applied to all modules on the system (when AC is applied and the battery is fully charged). If less than 12.5VDC is applied, system operation will be adversely affected.

To correct the problem, try any or all of the following:

1. Connect a PC4204/PC4204CX power supply near the module to provide power to the Combus.
2. Reduce the length of the Combus run to the module.
3. Increase the gauge of wire.

## Capacitance Limits

An increase in capacitance on the Combus will affect data transmission and will cause the system to slow down. Capacitance will increase for every foot of wire added to the Combus. The capacitance rating of the wire used will determine the maximum length of the Combus.

For example, 22-gauge, non-shielded, 4-conductor wire has a typical capacitance rating of 20 picofarads per foot (which is 20nF/1000'). For every 1000' of wire added – regardless of where it is run – the capacitance of the Combus will increase by 20nF.

The following chart indicates the total Combus wire allowed depending on the capacitance rating of the wire used:

Wire Capacitance per 1000'(300m)	TOTAL Combus Wire Length
15nF	5300'/1616m
20nF	4000'/1220m
25nF	3200'/976m
30nF	2666'/810m
35nF	2280'/693m
40nF	2000'/608m

Wires run in parallel also increase Combus capacitance. For example, when using 20nF wire, the following would be some of the combinations allowed:

- Four wire runs at 1000'/305m each
- Six wire runs at 666'/203m each
- Eight wire runs at 500'/152m each
- 10 wire runs at 400'/122m each etc...

**NOTE:** Contact the wire manufacturer for the capacitance ratings of the wire being used.

### PC4204/PC4204CX Power Supply

PC4204/PC4204CX power supply modules are required to power additional modules and devices when the total current from the main panel is insufficient. A PC4204/PC4204CX should also be used if excessive line loss is encountered.

### PC4204/PC4204CX Current Requirement

**AUX** - 1.0A available for devices connected to the AUX terminal, including devices connected to relay outputs and modules connected for Combus repower (see 2.5 'Combus Operation and Wiring').

### Combus Repower

Only Relay 1 on the PC4204/PC4204CX can be used for Combus repower. The Combus must be wired to the PC4204/PC4204CX according to the following diagram for Combus repower:

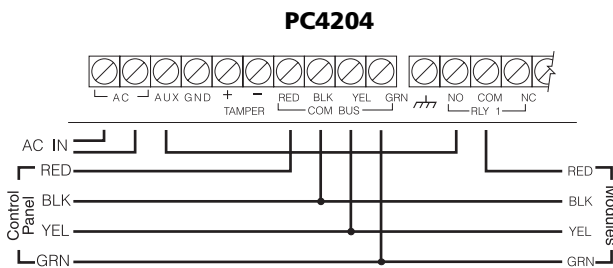

## PC4204CX

### Wiring for Combus Repower and Regeneration

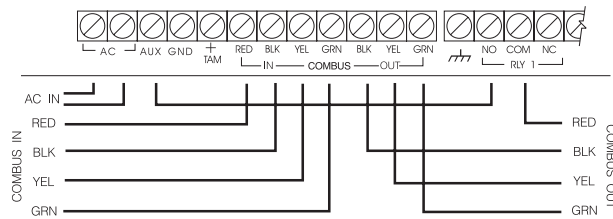

**IMPORTANT NOTE:** Do not use any power supply other than the PC4204/PC4204CX to repower the Combus. In the event of a power surge or transient, a module may lock up and cease to communicate with the control panel. If the panel loses communication with the module, it will initiate a module reset and will power down the Combus for five seconds in an attempt to reset the problem module. After five seconds, the panel will reapply power to the Combus and the problem module should begin to operate as intended.

**NOTE:** If a power supply other than the PC4204/PC4204CX is used, the Combus repower function will not operate as intended.

**NOTE:** New versions of the PC4204/PC4204CX power supply module have a jumper marked 'J1'. Ensure that this jumper is configured for 'Combus Relay'. Otherwise, the power reset function will not operate. For more information regarding the PC4204/PC4204CX, please refer to the PC4204/PC4204CX Installation Instructions.

## 2.6 Zone Wiring

Zones on the system are wired according to the diagrams below. Once you have selected which type of zone supervision you require, you must program the 'Zone Supervision' section. See 5.1 'Zone Supervision' for instructions.

**NOTE:** Fire, LINKS Supervisory, LINKS Answer, AC Delay or Forced Answer zones always use single EOL supervision, regardless of the programmed zone supervision.

### No End of Line (No EOL)

All No EOL zones are normally closed loops. The zone will be violated when it is open.

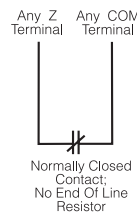

### Single End of Line (EOL)

All Single EOL zones have a 5600Ω resistor across them. If the zone is shorted or open, it will be violated. Resistors should always be placed at the device end of the wire run.

If programmed as a fire or waterflow zone, the open zone will generate a trouble condition and the short will generate an alarm.

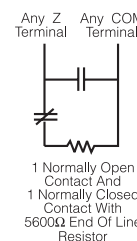
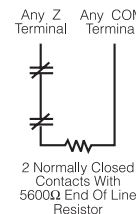
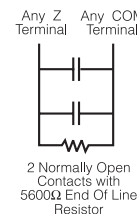

### Double End of Line (DEOL)

All Double EOL zones have two 5600Ω resistors across them. DEOL loops will allow the panel to detect zone faults, zone tampers, violated zones and restored zones.

Resistors should always be placed at the device end of the wire run.

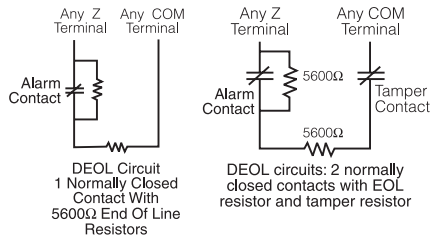

**NOTE:** Only normally closed detection devices can be used with this type of zone supervision. Only one normally closed contact can be connected to each zone; multiple detection devices/ontacts on one loop are not allowed, the tamper condition will not be monitored.

### 2.7 Specialized Zone Wiring

Some zones require wiring configurations unique to the selected zone type. These zones are listed below. For information regarding the various zone types, please see 5.4 'Zone Programming'.

#### Fire Zone

This zone type uses normally open contacts. The zone will initiate a fire alarm when the loop is shorted (contacts close). A Fire Zone trouble will be generated when the loop is opened (wire break). Typically, fire alarm initiating contacts originate from 4-wire smoke detectors. These types of detectors must be wired as shown in the diagram below.

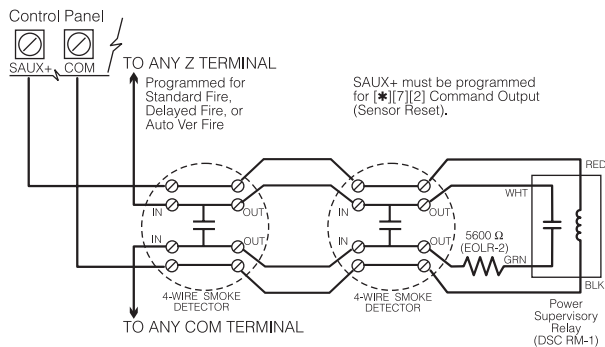

The power for the 4-wire detectors must be supervised with an end-of-line relay (RM-1). The contacts of that relay are wired in series with the zone end-of-line resistor. With the relay energized, the relay contacts are closed and the zone is normal. If the power is lost, the relay de-energizes, the contacts open and a zone trouble is initiated.

Multiple fire initiating normally open contacts may be used in parallel on the loop. Do not include burglary or other types of devices on a fire zone.

**NOTE:** Minimum 18 AWG wire is required for Listed Residential Fire Alarm Systems.

#### Keyswitch Zone

Zones programmed as keyswitch arming zones must be wired according to one the following diagrams:

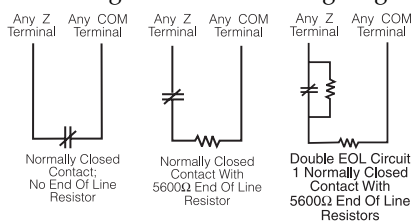

#### LINKS Supervisory Zone

This zone is for use with a LINKS1000/LINKS2150/LINKS2450 only. If the LINKS experiences a trouble condition, a LINKS output can be used to violate this zone type and the event will be reported to the central station. See the corresponding LINKS *Installation Manual* for wiring information.

#### LINKS Answer Zone

This zone is for use with a LINKS1000 only. In case of a telephone line failure, the panel can be uploaded/downloaded via the cellular network. If the LINKS detects an incoming call, it will activate an output that can be used to violate this zone type. This will force the panel to answer the cellular call and will begin communications with the downloading computer. This zone must be programmed as LINKS Answer and wired according to the following diagram:

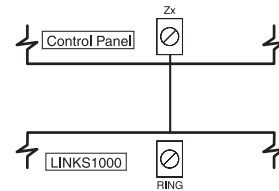

#### AC Delay Zone

This zone is for use with a LINKS1000. If the LINKS experiences an AC trouble condition, a LINKS output can be used to violate this zone type and the event will be reported to the central station.

See the corresponding LINKS *Installation Manual* for wiring information.

### 2.8 Programmable Output Wiring

The PGM output is a programmable terminal and will connect to +12V when activated. The terminal can source a maximum current of 50mA. If the desired current is higher than 50mA, a relay will be required. To connect the relay, refer to the above diagram. Each output can be programmed as one of numerous available output options. See 11.3 'Programmable Output Options' for a complete list of PGM output options.

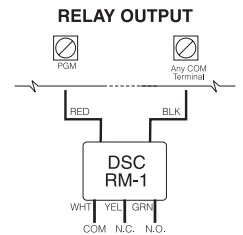

### 2.9 AML Device Wiring

Addressable Multiplex Loop (AML) devices use a 2-wire connection for power and to communicate to and from the control panel. All detectors are designed for low power consumption to make for an efficient system.

The system can accommodate up to 128 addressable devices. Connect the addressable loop to PGM1 and/or PGM2, when programmed for AML operation. If only one loop is used, then all 128 devices can be on the loop. If both PGM1 and PGM2 are used, the 128 devices can be divided between the two in any ratio that suits the application.

For instructions on configuring PGM1/PGM2 for AML operation, and for AML device enrollment, see 4.4 'Enrolling AML Devices'.

**NOTE:** The panel must be powered down when adding or removing devices from the AMLbus.

### Addressable Devices

The following addressable devices are available:

- AMS-220/220T smoke detector with optional temperature sensor\*
- AMB-300 PIR detector
- AMB-500 ceiling PIR detector
- AMB-600 dual PIR detector
- AMA-100 glass break detector
- AMP-700 magnetic door/window contact
- AMP-701 contact input module
- AMP-702 fire alarm contact input module
- AMX-400 repeater/isolator module
- AML-770 isolator module

\*Fire alarm devices cannot be placed on the same loop as burglary devices.

### Addressable Loop Response Time

The overall system response time for devices on the AML loop depends on how many devices are on each loop.

The response times below include three factors:

- input debounce time
- addressable reporting and confirmation time
- processing time required by the panel to activate the output

### Response Time (seconds)

$$\text{Response Time} = 1.348 + (0.036 \times \# \text{ of zones})$$

Use this formula on the PGM with the greater number of zones to find the loop response for both PGMs.

### Addressable Loop Current Calculation

Each addressable multiplex loop can draw a maximum of 170mA of current from the main panel. In order to determine the amount of current required for the AML loop, complete the following chart:

### Addressable Loop Current Calculation Chart

Item	Current (mA)	x	Quantity	Total (mA)
AMS-220/T	0.8	x		
AMB-300	2.5	x		
AMB-500	.75	x		
AMB-600	3.5	x		
AMA-100	3.5	x		
AMP-700	0.8	x		
AMP-701	0.8	x		
AMP-702	0.8	x		
<b>Total Current =</b>				

When more AML devices are added to a single loop, the current draw increases. The loop wire length must be limited to the following distances depending on the total loop current:

Loop Current vs. Wiring Distance		
TOTAL LOOP CURRENT(MA)	22 AWG DISTANCE(FT/M)	18 AWG DISTANCE(FT/M)
10	2880/878	5143/1568
20	1620/494	3645/1111
30	1010/308	2520/768
40	771/235	1736/529

Loop Current vs. Wiring Distance		
50	600/183	1250/381
60	500/152	980/298
70	400/122	800/244
80	321/98	720/220
90	250/76	500/152
100	200/61	310/95
110	165/50	220/67
120	135/41	155/47
130	115/35	130/39
140	106/32	126/38
150	100/30	124/37
160	98/29	122/36
170	96/28	120/35

### Addressable Loop Wiring

AML devices can be home-run, connected in a daisy chain, or T-tapped. Wire the AML loop according to the following diagram:

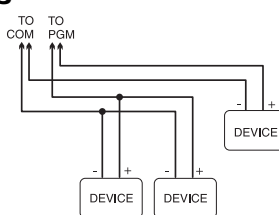

This configuration is only used for AML devices. Please see the *Installation Instructions* provided with each device for more information regarding operation and wiring.

For longer wire runs, you can split the addressable devices onto two or more loops from the COM and PGM terminals. For example,

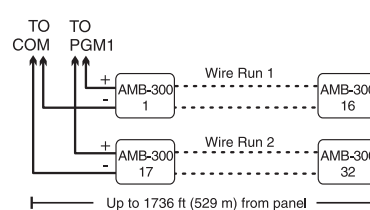

32 AMB-300 detectors (2.5mA each) take 80mA total. In one 18AWG wire run, this would allow a maximum length of 720 feet (220 m). If you split the 32 devices into two wire runs of 16 detectors each, using 18AWG wire, each wire run could be 1736 feet (529 m) long. See the diagram above.

**NOTE:** No end-of-line resistors are required when installing these devices.

**NOTE:** Once the devices are connected, the PGM terminal must be configured for AML operation and each device must be enrolled. See Section 4.4 'Enrolling AML Devices' for instructions.

**NOTE:** Do not use shielded wire runs in parallel with each other. Do not run either AML wire run in parallel with the Combus. Maintain minimum 2" separation between all AML wiring and Combus wiring.

## 2.10 Wiring Powered Devices (AUX, SAUX+)

### AUX – Auxiliary Power

These terminals can be used to power motion detectors, glass break detectors and other devices requiring power. The AUX (positive) and GND (negative) terminals can provide up to 500mA of current.

### SAUX+ – Switched Auxiliary Power

This terminal provides positive power (12VDC) and can be de-energized via the [\*][7][2] keypad command (provided that the output is programmed as Command Output #2).

Typically, this output is used for providing power to latching type devices that require a power interruption in order to reset.

### 2.11 Telephone Line Wiring

The telephone terminals provide connections to the incoming telephone lines for central station reporting. The wires from the RJ-31X jack must be connected in the following manner:

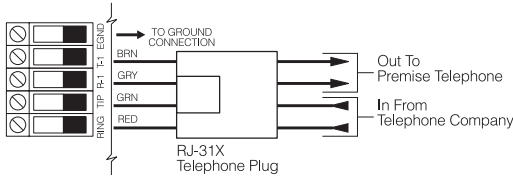

**NOTE:** There must be no other telephone equipment connected between the control panel and the incoming telephone line (e.g. answering machines, fax machines, telephones, etc.). Ensure that plugs and jacks meet the dimension, tolerance and metallic plating requirements of 47 CFR Part 68 Subpart F.

### 2.12 Bell Output Wiring (BELL+ and BELL-)

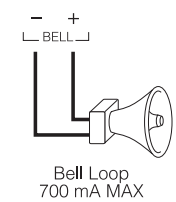

Be Sure To Observe Polarity When Connecting Polarized Sirens Or Bells

These terminals are used for powering bells, sirens or other devices requiring steady output voltage on alarm. The panel can provide up to 2A short-term or 700mA long-term current. The output is supervised. A trouble condition will be generated when the bell connection is lost. If no bell or siren is being used, connect a 1000Ω resistor across the BELL+ and BELL- terminals to eliminate a trouble condition.

To ensure proper operation, the wire length of the bell loop must be considered.

Consult the following chart to determine the maximum wire length for the bell loop with respect to current. The values reflect the use of a 30 watt siren.

Bell Loop Load Current	Distance to last bell/siren (ft/m)				
	22 AWG Wire	20 AWG Wire	18 AWG Wire	16 AWG Wire	14 AWG Wire
2000mA	18/6	29/9	46/14	73/22	116/35
1800mA	20/6	32/10	51/16	81/25	129/39
1000mA	36/11	58/17	92/28	147/44	233/70
700mA	52/16	82/25	132/40	210/64	332/101
500mA	73/22	115/35	184/56	293/89	465/141
100mA	364/110	577/175	922/279	1467/445	2326/705

To increase the length, double up on wire. For example, when using 22-gauge quad, use two conductors for the Bell+ connection and two for the Bell-. This effectively doubles the maximum distance.

For UL residential installations, when a bell or siren is used for fire signaling with a pulsed cadence, it must be connected between the AUX+ and BELL- terminals. To maintain bell circuit supervision, do not connect more than one device to the BELL- terminal. A fire bell or siren used for this application must be UL Listed and have a current consumption of 400mA or less (e.g. Wheelock MT-12/24-R).

**NOTE:** For Commercial Fire applications, you must use the 'CF' version of the panel and the PC4702BP.

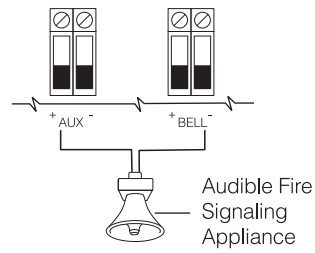

### 2.13 Earth Ground Wiring

The cabinet should be earth grounded using the grounding kit supplied. Ensure that the connection from the cabinet to the metallic cold water pipe or earth grounding rod is made with minimum 14-gauge solid copper wire.

The EGND terminal must be connected to earth ground to enable ground fault detection. A Ground Fault trouble will be indicated if any conductor on the system has a resistance to earth ground of 40kΩ or less.

Only earth ground the main panel and the first module connected to the telephone line.

Tighten nut to break paint and make good connection to the cabinet

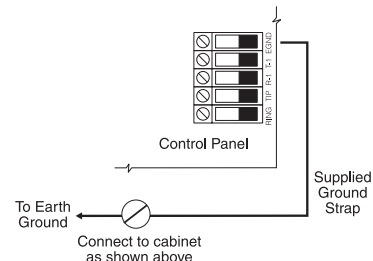
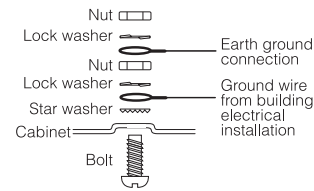

### 2.14 Applying Power (AC and Battery)

**WARNING:** Do not connect the battery or transformer until all other wiring is complete.

#### Battery Connection – Red & Black Battery Leads

Connect the red battery lead to the positive terminal of the battery and the black lead to the negative terminal.

**WARNING:** Observe the correct polarity. If the battery is connected backwards, the panel will not operate.

#### AC Power Terminals

**WARNING:** Connect the battery before connecting the AC.

A 16V, 40 VA transformer connected to an unswitched AC power source should be wired to these terminals.

To achieve the rated outputs as previously described, the AC input must be connected to the secondary of a transformer rated at 16 VAC, 40VA minimum. The transformer is not supplied with the equipment and must be mounted outside the cabinet.

Do not connect the transformer primary to an outlet that is controlled by a switch.

The control panel monitors the presence of AC. Upon the loss of AC power a trouble condition will be generated. The keypad trouble light will turn on. If programmed, the keypad will also beep. For more information regarding AC options, see 10.1 'AC/DC Power Options'.

**Applying Power to the Main Panel**

Once all field wiring has been completed and checked for opens, shorts and grounds, power can be applied to the panel as follows:

1. Connect the battery leads.
2. Connect the AC transformer.

The panel will not power up correctly if AC power is applied before the battery is connected.

**Battery Selection Charts**

The charts below are to determine the battery required to support the main panel for either 24 hours or 60 hours in the standby mode. The battery size is measured in amp hours (Ah). To determine the appropriate battery size, perform the following:

1. Calculate the total current required when the panel is not in alarm. This is the standby current. See section 2.4 for further information on current calculation.
2. Determine the current that will be drawn when the panel is in alarm.
3. On the chart below, find the standby current on the horizontal axis and the alarm current on the vertical axis.
4. Find the region of the chart where the standby current and the alarm current values intersect. The region corresponds to the required battery Ah capacity.

**For example:**

Standby current = 500 mA

Alarm current = 2 A

On the 24Hr chart, the battery capacity required is **14Ah**.

**2.15 Lithium Batteries**

The PC4020 circuit board includes a lithium battery (please see the wiring diagram on page ii.) This battery is not replaceable. There is a danger of explosion if the battery is incorrectly replaced.

If the lithium battery stops working, return the circuit board to your distributor. Batteries may cause a fire when in contact with metal. If you need to dispose of the circuit board and/or the lithium battery, wrap the battery in non-conductive tape. Check with your local government for battery disposal regulations.

**WARNING:** Do not store the batteries in such a way that they come into contact with each other or with any piece of metal. Explosion or fire may occur. Should fire occur, use only dry chemical fire extinguishers. Do not use water to put out the fire.

Do not heat the batteries. Do not dispose of the batteries or circuit boards in a fire. Do not disassemble the batteries. Do not apply pressure to or deform the batteries. Ensure that the above precautions are strictly observed by related departments, including, but not limited to, production, sales and outside contractors.

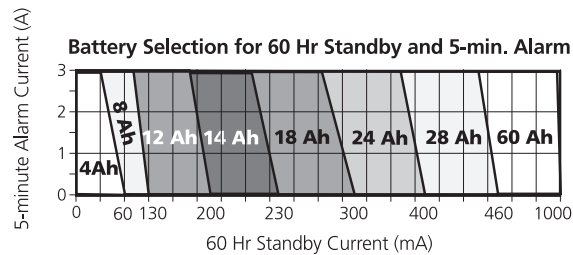
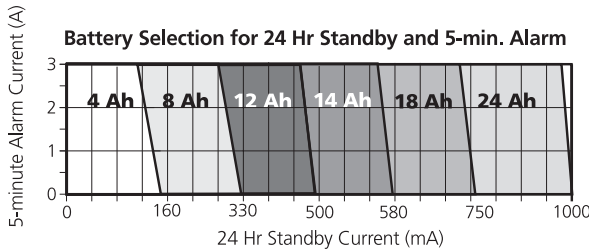

# Section 3: How to Program

---

## 3.1 Introduction to Programming

The PC4020 is programmed via a menu system. Use the arrow keys (<>) to scroll through different menu options and press the [\*] key to select the menu option displayed. Continue this procedure until the required program section is displayed, then press the [\*] key to select it. To arrive at a program section where data can be entered may require scrolling and selecting items from several menus. Press the [#] to return to the previous menu.

To enter Installer's Programming, enter [\*][8][Installer's Code] at any keypad that is enrolled on the system.

In order to prevent unauthorized personnel from accessing Installer's Programming, the Installer's Code should be changed from the default setting. By default, the Installer's Code is [5555]. To change the Installer's Code, see 7.1 'Installer's Code'.

Once you have entered Installer's Programming, the first menu consists of five items, listed below. Use the arrow keys (<>) to scroll to the desired menu item and press the [\*] key to select it:

- **System Area** - These programming options affect the operation of the entire system. These options include communications, downloading, printer options, installer and master code programming, etc.
- **Partition Area** - These options are programmed for each partition. These options include zone assignments, partition times, partition options etc.
- **Module Hardware** - This menu is used when you enroll the system modules and keypads.
- **Event Buffer** - This menu allows access to the system's event buffer for printing.
- **Diagnostics** - These options pertain to trouble conditions reported by the modules.

Use the arrow keys to scroll to the message indicating the area you wish to program and press [\*]. For example, to program the Partition 2 account number, scroll to each of the following messages and press [\*]:

Scroll to...	<table border="1"><tr><td>PARTITION AREA</td><td>&lt;&gt;</td></tr><tr><td></td><td>(01)</td></tr></table>	PARTITION AREA	<>		(01)	Press [*]
PARTITION AREA	<>					
	(01)					
	<table border="1"><tr><td>ADD/EDIT PAR</td><td>&lt;&gt;</td></tr><tr><td></td><td>(01)</td></tr></table>	ADD/EDIT PAR	<>		(01)	Press [*]
ADD/EDIT PAR	<>					
	(01)					
Scroll to...	<table border="1"><tr><td>PARTITION 2</td><td>&lt;&gt;</td></tr><tr><td></td><td>(02)</td></tr></table>	PARTITION 2	<>		(02)	Press [*]
PARTITION 2	<>					
	(02)					
	<table border="1"><tr><td>PARTITION ACCT #</td><td>&lt;&gt;</td></tr><tr><td></td><td>(00)</td></tr></table>	PARTITION ACCT #	<>		(00)	Press [*].
PARTITION ACCT #	<>					
	(00)					

Enter the 4-digit Partition 2 customer ID code. The display will return to the 'Customer ID Code' display. Press [#] to return to the previous menus and to exit the installer programming mode.

The arrow keys (<>) will appear in the top right-hand corner of the display to indicate that there are multiple menu items or program sections.

## 3.2 Programming by Reference Number

A quicker method of programming the panel is to jump directly to a program section using the reference number system. These reference numbers appear beside each programming item in the *Programming Worksheets*, and under each heading in the *Installation Manual*.

To program using reference numbers, enter Installer's programming([\*][8][Installer's Code]). Press and hold the [A]uxiliary key until the keypad displays the following message:

**'Enter Ref # then \*'.**

Enter the reference number found in the *Programming Worksheets* for the section you wish to program, then press the [\*] key. The display will immediately go to the programming item you have selected.

For example, the reference number for the Partition 2 Account Number is [0100XX00]. The 'XX' is the 2-digit partition number, in this case [02].

Once the Reference Number is entered and the [\*] key is pressed, the keypad will jump directly to that programming item. If an error is made when entering the reference number, use the [<] key to move the cursor back to the first digit and re-enter the reference number.

Once you have programmed the section, *you must press [#] to save the change*. Then, press and hold the [A] key to enter another reference number.

Once you become familiar with each programming option's reference number, programming will become quick and simple. If you forget a particular reference number, you can always scroll through the menu items in order to refresh your memory. All programming reference numbers are listed in the *Programming Worksheets*.

## 3.3 Programming Decimal Data

Some programming sections require decimal (0-9) entries, such as zone definitions and system times. Make sure to record all required decimal data in the *Programming Worksheets* before beginning to program each section.

Many sections require a specific number of digits. Once all digits have been entered, the control panel will automatically exit that section and will return to the previous menu.

If the [#] key is pressed, only the data entered will be changed. All programming data remaining will be left unchanged. For example, when programming telephone numbers, press the [#] key after the number is entered to exit the programming item and to save having to program all 32 digits.

### 3.4 Programming Hexadecimal Data

Hexadecimal or 'Hex' digits are often required for a programming item, such as telephone numbers and reporting codes. To insert a Hex digit into a given entry, press the [\*] key to enter the Hex menu. Use the arrow keys to scroll through the each Hex digits (A through F). When the desired letter is displayed, press the [\*] key.

Hex digits can also be entered by pressing [\*] key followed by the number from 1-6 corresponding to each Hex letter (A = 1, B = 2, C = 3, up to F = 6). Once the digit is entered, the control panel will automatically return to the decimal programming mode.

For example, to enter data 'ABCD' on a PC4020 you would enter: [\*], [1], [\*], [2], [\*], [3], [\*], [4]

### 3.5 Programming Toggle Options

Many programming items are toggle options that are either enabled or disabled. Use the arrow keys (< >) to scroll through the toggle options. Press the [\*] key to switch back and forth between [Y]es (enabled) and [N]o (disabled). Once all the toggle options have been programmed, press the [#] key to save your changes and return to the previous menu.

# Section 4: Module Enrollment

---

## 4.1 Enrolling Keypads and Modules

Once the wiring of all keypads and modules is complete, they must be enrolled on the system. Apply power to the system by first connecting the battery, followed by the AC transformer. All LCD keypads will display the software version of the keypad.

**NOTE:** Make sure all power to the system is OFF when connecting modules.

**NOTE:** Record the location and number of each module for future reference.

### Enrolling the First Keypad to Partition 1

To enroll the first keypad, go to the keypad that is to be assigned to Partition 1. Press any key on that keypad. The keypad will beep and display the message '45XX Mod. #1'. This keypad will automatically be assigned to Partition 1.

Once the first keypad has been enrolled, the rest of the system keypads and modules can be enrolled through the 'Module Hardware' section of installer's programming.

### Enrolling All Other Keypads and Modules

Ref # [0200] then scroll to desired module

Enter the following at the keypad you have just enrolled:

1. Enter installer's programming by pressing [\*] [8] [Installer's Code].

**NOTE:** The default installer's code is [5555].

2. Scroll to 'Module Hardware' and press the [\*] key.
3. The message 'Enroll Module' will appear. Press [\*].
4. Scroll through the different modules until the module you wish to enroll is displayed. Press the [\*] key.

### LCD45XX Keypads

The keypad will display the message 'Press Any Key On Desired Unit'. Go to the keypad to be enrolled and press any key. Return to the original keypad. A message similar to the following will be displayed to confirm enrollment (e.g. 'LCD45XX Mod 02 Enrolled').

**For keypads:** next, you must select which partition the keypad is to control. Use the arrow keys to scroll to the desired partition and press the [\*] key to select. If the enrolled keypad is slated for global operation, scroll to Option 00 'Global' and press [\*].

If you press the [#] key, the keypad will be assigned to Partition 1 by default.

For more information regarding partition and global keypads, see Section 6: 'Keypad Operation'.

### Module Tamperers

When enrolling PC4108A, PC4116, PC4204/PC4204CX, PC4216, PC44XX, PC4702, PC4820, PC4850, PC4164 or alternate communicator modules, the message 'Create Tamper On Desired Unit' will be displayed. The tamper is required for enrollment.

To create the required tamper, secure the tamper zone on the module and then open it. It is this transition from secure to violated which enrolls the module. After this is done, the keypad will display the module number and will confirm enrollment (e.g. 'PC4204/PC4204CX Mod 01 Enrolled'). Record the module number in the programming worksheets. Once the module is enrolled, re-secure the tamper.

## Zone Expanders

**NOTE:** Enroll all zone expanders before assigning zones to PC4820 and AML devices.

When enrolling zone expanders (PC4108A, PC4116 and PC4164), the panel will display 'PC41XX Module'. It does not ask what type of expander is being enrolled. Once the tamper is created, the control panel will automatically indicate the type of expander and will confirm enrollment (e.g. 'PC4116 Mod 01 Enrolled').

Zones 1 to 16 are located on the main control panel. Additional zones are added in sequence. For example, if two PC4108A zone expanders are enrolled, the first one enrolled will be assigned zones 17 to 24 and the second will be assigned zones 25 to 32.

The system can have a maximum of 128 zones. To confirm which zones are assigned to which expander, press any key when the enrollment confirmation message is displayed.

**NOTE:** Be sure to record the zones assigned to each zone expander module in the System Overview section of the Programming Worksheets.

The PC4164 is a wireless receiver. When you enroll a PC4164 module, you can enroll up to 64 wireless devices on the system.

You can enroll up to eight PC4164 wireless receivers. This will give you a greater range in which to install wireless devices. It will also allow you to install backup wireless receivers with overlapping ranges, to provide increased security for the wireless zones on the system.

**NOTE:** The maximum number of wireless zones you can enroll on the system is 64, even if you install more than one PC4164 wireless receiver.

### ESCORT4580, PC4701 and PC4936 Enrollment

When enrolling the ESCORT4580, the PC4701 or the PC4936, the keypad will display the message 'Looking for PC4XXX Module'. The panel will automatically scan the Combus for the module. Once it is found, the panel will confirm enrollment (e.g. 'ESCORT4580 Module Enrolled'). No tamper is required.

## 4.2 Deleting Modules

Ref # [0201] then scroll to desired module

Sometimes, a module must be deleted from the system. This could be when zone expanders are enrolled out of sequence or if a module is defective.

To delete a module, enter the following at any enrolled keypad:

1. Enter installer's programming by pressing [\*] [8] [Installer's Code].
2. Enter reference number [0201] then press [\*].
3. Scroll through the different modules until the module you wish to enroll is displayed. Press [\*] to select.
4. Scroll to the correct module type, then to the correct module number. For example, to delete LCD45XX Module 04, scroll to 'LCD45XX (04)'. Press the [\*] key to delete the module.

**NOTE:** When deleting and/or replacing zone expanders, all remaining zone expanders should be re-enrolled. This will ensure proper zone assignment and operation.

### 4.3 Confirming Modules

Ref # [0202] then scroll to desired module

In case module numbers were not recorded, you can verify this information through the 'Confirm Module' menu in the 'Module Hardware' programming section in installer's programming.

This works just like enrolling modules. You will be prompted to 'Press Any Key On Desired Unit' in the case of keypads and 'Create Tamper on Desired Unit' in the case of modules. Once the correct action is taken, the keypad will display the module number (e.g. LCD45XX Mod 02).

### 4.4 Enrolling AML Devices

Addressable Multiplex Loop (AML) devices use a 2-wire connection for power and communication to and from the control panel. All detectors are designed for low power consumption to make for an efficient system.

For information on AML wiring, please see 2.9 'AML Device Wiring'.

Enroll the AML devices *after* all PC4108A, PC4164 and PC4116 modules have been enrolled.

#### Programming the PGM Terminal for an AML Loop

Ref #: [001400]

To enroll addressable multiplex loop (AML) devices, you must first program the PGM terminal you have selected for the loop. Perform the following:

1. Enter Installer's Programming and enter reference number [001400].
2. To select PGM1 for AML devices, scroll to 'PGM1 AML?' and press [\*]. The option will toggle to Yes.
3. To select PGM2 for AML devices, scroll to 'PGM2 AML?' and press [\*]. The option will toggle to Yes.

**NOTE:** Do not turn off the PGM AML toggle option unless all AML devices have been removed from the loop (see 'Removing AML Devices').

#### To Enroll an AML Device

Ref #: [00140300] for PGM1

Ref #: [00140400] for PGM2

**NOTE:** All AML devices must be connected before they are enrolled.

To enroll the device, perform the following:

1. FOR DEVICES TO BE ENROLLED ON PGM1: Enter Installer's Programming and enter reference number [00140300].  
FOR DEVICES TO BE ENROLLED ON PGM2: Enter Installer's Programming and enter reference number [00140400].
2. Enter the 5-digit serial number on the detector to be enrolled.
3. If the correct serial number was entered, the panel will allow you to select the zone that the addressable detector will be assigned to. Any zone from zone 001 to 128 on the PC4020 v3.3 can be used as an AML zone. If the detector is not connected to the PGM terminal, the zone will not be enrolled. *Do not use zones designated for Access Control.*

Repeat from Step 2 until all AML devices have been enrolled. If the zone serial number is already programmed into the panel, the panel will display the message 'Already Enrolled' on the top line of the LCD and the serial number on the bottom line of the LCD for three seconds. The panel will then display the zone assignment for the device. This allows for the reassignment of an existing zone or to verify programming.

**NOTE:** Only the AMS-220/220T devices may be defined as fire zones. Do not program other AML devices as fire zones.

#### AML Key

Ref #: [001401]

**IMPORTANT NOTE:** To ensure system security, the AML Key must be programmed when using AML devices.

The AML Key is a 2-digit code that acts as a security lock for the AML detectors. Once you have enrolled all AML zones, you must change the AML Key from [00] to another 2-digit number (01-FF). When the AML Key is changed, the panel broadcasts the new code to each addressable device. Any device added to the system with a AML Key other than the one programmed or the default [00] will not function.

When an addressable device is deleted, the panel reprograms the device's AML Key to 00. This allows the device to be re-enrolled on another system.

#### Moving AML Devices

##### To another zone on the same loop

1. FOR DEVICES TO BE MOVED ON PGM1: Enter Installer's Programming and enter reference number [00140300].  
FOR DEVICES TO BE MOVED ON PGM2: Enter Installer's Programming and enter reference number [00140400].
2. Enter the device's 5-digit serial number. The keypad display will read 'Already Enrolled [serial number]' to indicate that the device has already been enrolled.
3. After three seconds, the display will indicate the device's zone assignment. Enter the new zone number. Any zone from zone 001 to 128 on the PC4020 v3.3 can be used as a AML zone.
4. The zone definition and attributes must also be programmed for the new zone.

##### To another zone on a different loop

When moving devices to another loop, they must be deleted from the first loop by following the instructions in 'Removing AML Devices' (see below). The device's serial number can then be re-entered on the other loop as indicated in 'To Enroll an AML Device' (see above).

#### Removing AML Devices

Ref #: [00140301] for PGM1

Ref #: [00140401] for PGM2

When removing AML devices, they must be deleted from the loop. If the device is not deleted, its AML Key will not be reset to [00].

To remove an AML device from the system, perform the following:

1. For devices to be deleted from PGM1: Enter Installer's Programming and enter ref# [00140301].  
For devices to be deleted from PGM2: Enter Installer's Programming and enter ref# [00140401].
2. The display will read 'Serial# [ ]' on the top line of the display and the zone label on the bottom line of the display. Use the [<]> keys to scroll to the zone to be deleted then press [\*]. The bottom line of the display will then read 'Zone Deleted'.
3. To delete all AML devices from the selected PGM output, select Default AML. The panel will display 'Confirm Default Press [\*]'. To delete all AML devices on the selected PGM, press [\*].

# Section 5: Partitions and Zones

---

## 5.1 Zone Supervision

Ref # [000204] 'Zone Supervision'

The control panel must be instructed to supervise either No End of Line, Single EOL or Double EOL zone loops. These three options are described in Section 2.5 'Zone Wiring'.

To program this option, perform the following:

1. Enter installer's programming by pressing [\*] [8] [Installer's Code].
2. Enter reference number [000204] and press [\*].
3. Scroll through the three supervision types. Press [\*] to select the supervision type you require.

## 5.2 Creating Partitions

Once all system wiring has been completed and you have enrolled your keypads and modules, you can begin programming partitions. This will include indicating the number of partitions and programming the available options for each. Partitions must be programmed individually.

**NOTE:** If you do not wish to use partitions, you must assign all zones which will be used to Partition 1 (see 5.3 'Adding Zones to Partitions').

There are five basic programming items for each partition:

1. Programming the partition account number.
2. Programming the partition toggle options.
3. Programming the partition times (entry and exit delay times, etc.).
4. Adding zones to the partition and defining each zone (zone label, zone type and attributes).
5. Programming the partition label.

### Partition Account Number

Ref #: [0100XX00] where XX = partition number

Enter a 4 or 6-digit partition account number. Partitions can all report using the same account number, or each can be programmed differently depending on your application. Enter the four or six digits and record them into your *Programming Worksheets*. Once you have entered all the digits, the display will return to the 'Partition Acct #' prompt..

### Partition Toggle Options

Ref #: [0100XX01] where XX = partition number

There are numerous partition options which can be either enabled (select 'Y' for yes) or disabled (select 'N' for no). Pressing [\*] will toggle between the yes and no options.

The following partition toggle options generally pertain to the operation of the keypads, the entry and exit delay options and the end user feature accessibility for the selected partition. These features are explained in detail in other sections of the manual. Below is a list of the available options followed by their default. Each option is described later in this manual in the specified sections.

- [F] Enabled (Y) ..... see section 6.5 on page 19
- [A] Enabled (Y) ..... see section 6.5 on page 19
- [P] Enabled (Y) ..... see section 6.5 on page 19
- Display Clock (Y)..... see section 6.1 on page 18
- Clock Armed (N) ..... see section 6.1 on page 18
- Disp Exit Time (Y)..... see section 6.1 on page 18

- Bypass Req Code (Y) ..... see section 7.9 on page 26
- AutoArm/Disarm (Y) ..... see section 8.2 on page 27
- Autoarm Req Code (N) ..... see section 8.2 on page 27
- Autoarm Squawk (N) ..... see section 8.2 on page 27
- Bell Squawk (N) ..... see section 8.1 on page 27
- Keypad Lockout? (N) ..... see section 6.6 on page 19
- Cmd. OutX Req Cd (N) ..... see section 7.9 on page 26
- [\*][6] Any Cd (N) ..... see section 7.9 on page 26
- Exit Delay Aud (N) ..... see section 9.2 on page 28
- Exit Delay Sqk. (N) ..... see section 9.2 on page 28
- Aud. Exit Fault (N) ..... see section 8.1 on page 27
- Entry Urgency (N) ..... see section 9.2 on page 28
- Entry Squawk (N) ..... see section 9.2 on page 28
- Exit Del. Term (N) ..... see section 9.2 on page 28
- System Alarms (N) ..... see section 6.1 on page 18
- System Status (N) ..... see section 6.1 on page 18
- Sen. Rst. Cmd#2 (Y) ..... see section 11.3 on page 33
- Spcl Alm Entry (Y) ..... see section 9.2 on page 28
- Exit Tbl Beep (N) ..... see section 9.2 on page 28

### Partition Times

Ref #: [0100XX02] where XX = partition number

There are eight different partition times to be programmed. See the corresponding section for further information regarding each timer:

- Entry Delay – section 9.1 'Entry and Exit Delay Times'
- Exit Delay – section 9.1 'Entry and Exit Delay Times'
- Auxiliary Entry Delay – section 9.1 'Entry and Exit Delay Times'
- Auxiliary Exit Delay – section 9.1 'Entry and Exit Delay Times'
- Delinquency – a Closing Delinquency reporting code will be sent if the partition is not armed for the number of days programmed in this section.
- Autoarm Pre-alert – section 8.2 'Automatic Arming'
- Quick Bypass Duration - '24Hr Quick Bypass (24)'
- Quick Bypass Pre-alert - '24Hr Quick Bypass (24)'

Three digits are required for each entry.

### Zone Assignment

Ref #: [0100XX03] where XX = partition number

This procedure is outlined in Section 5.3 'Adding Zones to Partitions'.

### Partition Labels

Ref #: [0100XX04] where XX = partition number

Program partition labels in this section. All system display labels are programmed in a similar fashion. For instructions on programming labels, see 5.4 'Zone Programming'.

### Deleting Partitions

Ref #: [0101]

Scroll to the partition to be deleted, then press [\*]. When a partition is deleted, the programming assigned to it will not be erased. If the partition is re-enabled, the programming that was entered will still be there.

**NOTE:** When a partition is deleted, the zones assigned to it are removed from the Zone Assignment.

### Copying Partitions

Ref #: [0102]

Enter this section to copy the programming from one partition to another one. The programming that will be copied includes the Customer ID Code, Partition Toggles, Partition Times, Access Code Levels and Command Output Labels. The zone assignment will not be copied. To copy a partition:

1. The panel will prompt 'From Which Partition'. Scroll to the partition you want to copy programming from. Press [\*].
2. The panel will prompt 'To Which Partition'. Scroll to the partition you want to copy programming to. Press [\*].

Both partitions now have the same programming.

## 5.3 Adding Zones to Partitions

### Add New Zone

Ref #: [0100XX0300] where XX = partition number

Zones must be assigned to partitions in order for them to operate. By default, the first 16 zones on the control panel are assigned to Partition 1. When you select this menu item, the panel will display the first zone not assigned to the partition. Use the arrow keys (<>) to scroll through the zones not assigned to the partition. When the zone to be added is displayed, press the [\*] key to select it.

Once you have selected the zone to add, there are three items to be programmed:

1. Zone Label: this 14-character label will appear on the LCD display of the keypad.
2. Zone Type: this determines how the zone will operate.
3. Zone Attributes: these attributes are toggled on and off and affect how the zone will function.

For instructions on programming these items, see 5.4 'Zone Programming'.

Press [#] once you have finished programming a zone. The keypad will display the next available zone to be added.

### Global Zones

If a given zone is added to more than one partition, it becomes a **global zone**. A global zone differs from single partition zones in the following ways:

- A global zone will not be armed until all partitions to which the zone is assigned are armed.
- A global Delay type zone will follow the longest programmed delay time of the partitions it is assigned to.
- A global Stay/Away type zone will not be activated until all partitions the zone is assigned to are armed in the Away mode, or the interior has been activated by pressing [\*] [1].
- When a global zone is manually bypassed, as soon as any partition the zone is assigned to is disarmed, the zone will no longer be bypassed.

### Edit Zone

Ref #: [0100XX0301] where XX = partition number

When you select this menu item, the panel will display the first zone assigned to the partition. Use the arrow keys (<>) to scroll through the zones assigned to the partition. When the zone to be edited is displayed, press the [\*] key to select it.

Adding and editing zones follow the same menu system. All options for editing a zone are described in Section 5.4 'Zone Programming'.

### Delete Zone

Ref #: [0100XX0302] where XX = partition number

When you select this menu item, the panel will display the first zone assigned to the partition. Use the arrow keys (<>) to scroll through the zones assigned to the partition. When the zone to be deleted is displayed, press the [\*] key to delete it. Press the [#] key to exit once all zones not required for the partition have been deleted.

## 5.4 Zone Programming

Ref #: [0100XX0301YYY] where XX = partition number and YYY = zone number

Once a zone has been added to a partition, you must program the following:

- zone label
- zone type
- zone attributes

To program the zone, enter the reference number indicated above. Press [\*] to select the zone. The three programming items are accessible from the zone programming menu.

### Zone Labels

When the zone label programming option is selected, the panel will display the presently programmed label (default 'Zone XXX'). Follow the instructions below to program the label.

### Programming System Labels

A cursor will appear under the first letter of the default label. Move the cursor to left or right by pressing the arrow (< >) keys. The letters of the alphabet have been divided up among the number keys 1 to 9 on the keypad as follows:

[1] = A, B, C, 1	[2] = D, E, F, 2	[3] = G, H, I, 3
[4] = J, K, L, 4	[5] = M, N, O, 5	[6] = P, Q, R, 6
[7] = S, T, U, 7	[8] = V, W, X, 8	[9] = Y, Z, 9, 0
[0] = Space		

For example, if you press the [4] key once, the letter 'J' will appear above the cursor on the display. Press the [4] key again, the next letter 'K' will appear, and so on. If a different number key is pressed, the cursor will automatically move to the right one space. To erase a character, use the arrow keys to move the cursor under the character, then press the [0] key.

There are other options when programming labels. Press the [\*] key to call up the options menu. Scroll through the options using the arrow (< >) keys, then press the [\*] key to select.

[0] **Clear Display** will clear the entire label.

[1] **Clear to End** will clear the display from the character above the cursor to the end of the display.

[2] **Change Case** will toggle between uppercase and lowercase letters.

[3] **ASCII Entry** is for entering uncommon characters. Use the arrow (< >) keys to toggle through the characters or enter a 3-digit number from 032 to 255. Press the [\*] key to enter the character. See Appendix D at the back of this manual for a list of the available ASCII characters.

[4] **Cancel and Exit** will exit zone label programming. No changes will be saved.

[5] **Save** will save any changes and exit zone label programming.

### Zone Types

The following is a description of each zone type:

#### Standard Delay (00)

Standard Delay zones have an entry and exit delay. The exit delay will begin as soon as arming is initiated. The delay zone may be opened and closed during the delay time without causing an alarm. After the exit delay time has expired, the zone is armed. Opening the zone will start the entry delay. If the panel is disarmed before the entry time expires, no alarm will be generated.

#### Auxiliary Delay (01)

The Auxiliary Delay zone operates the same way as the Delay zone, except different entry and exit delay times can be programmed: Auxiliary Entry and Auxiliary Exit Delay. Having a second delay zone provides greater flexibility for areas which require more time to arm and disarm the system.

#### Instant (02)

An Instant zone will be armed when the exit delay expires. Violating this zone when armed will cause an instant alarm.

#### Interior (03)

An Interior zone will be armed when the exit delay expires. If a Delay zone is violated first, this zone will wait for the Delay time before going into alarm. If this zone is violated first, it will create an instant alarm.

#### Interior Delay (04)

When the partition is armed in the Away mode (interior zones active), this zone will operate as an Interior zone. When the partition is armed in the Stay mode (interior zones bypassed), this zone will operate as a delay zone.

#### Interior Stay/Away (05)

This zone acts as an interior zone. The zone will be automatically bypassed if no delay zone on the partition is violated during the exit delay or if the partition is armed in the Stay mode.

#### Delay Stay/Away (06)

This zone will operate the same as the Delay zone with one exception: this zone will be automatically bypassed if the partition is armed in the Stay mode.

#### Standard Fire (07)

When a Standard Fire zone goes into alarm, the panel will activate all fire outputs and will immediately transmit a reporting code to the central station, if programmed. The fire output can be programmed to pulse—two seconds on, two seconds off—or to follow one of the other fire bell patterns (see 11.3 ‘Programmable Output Options’, options 49-53). If an open condition is present, the panel will immediately display and communicate a trouble condition. All keypads will annunciate the trouble by activating the Trouble light and beeping twice every ten seconds. The keypads can be silenced by pressing any key.

**NOTE:** Fire zones always require single EOL resistors regardless of any other programming. Never program a fire zone as silent. Refer to the wiring diagram or Section 2.9 ‘Zone Wiring’ for fire zone configuration.

#### Delayed Fire (08)

This fire zone works the same way as a Standard Fire zone except that the alarm memory and communication are delayed by 30 seconds. The fire outputs are activated

immediately. The alarm can be acknowledged by the user by pressing any key before the 30-second delay expires.

If the alarm is acknowledged, the panel will silence the alarm and delay communication of the signal for 90 seconds to allow the user a chance to correct the problem. If the Delayed Fire zone is still in alarm 90 seconds later, the panel will again activate the fire output and delay communication for 30 seconds, at which point the user can acknowledge the alarm again.

If the alarm is not acknowledged, the panel will latch the alarm after the 30-second delay and will communicate to the central station.

**NOTE:** Fire zones always require single EOL resistors regardless of any other programming. Never program a fire zone as silent. Refer to the wiring diagram or Section 2.9 ‘Zone Wiring’ for fire zone configuration.

#### Auto Verifying Fire (09)

Auto verify Fire zones operate similar to Standard Fire zones. When the zone goes into alarm, the panel will perform a sensor reset for 20 seconds and then will wait 10 seconds for the detectors to clear. If the same zone goes into alarm within 60 seconds, the panel will immediately activate the fire outputs and will communicate to the central station, if programmed.

**NOTE:** In order for this zone to operate, the smoke detector power supply must be connected to an output programmed as Command Output #2.

**NOTE:** Fire zones always require single EOL resistors regardless of the programmed zone supervision. Never program a fire zone as silent. Refer to the wiring diagram or Section 2.9 ‘Zone Wiring’ for fire zone configuration.

#### Waterflow (10)

When an alarm occurs, the fire outputs will activate. If programmed, the panel will immediately send a Waterflow Alarm reporting code to the central station. The Waterflow zone will also follow the Waterflow delay, if programmed (see 10.9 ‘Transmission Delay’).

**NOTE:** Waterflow zones always require single EOL resistors regardless of any other programming. Refer to the wiring diagram or Section 2.9 ‘Zone Wiring’ for zone configuration.

#### Fire Supervisory (11)

A Fire Supervisory zone monitors fire critical systems to indicate when those systems are in a condition that could prevent normal operation. This zone will indicate an ‘Off-Normal Supervisory’ condition when a short circuit is detected. When the zone is open, a zone trouble will be indicated and the keypad will beep. This zone will not activate the verbal alarm feature on the PC4936.

#### 24 Hour Zones (Types 12-23)

These zones are always active. When violated, they will create an alarm, whether the partition is armed or disarmed.

**For Types 16-21:** When violated, the panel will immediately latch the bell outputs and will communicate to the central station. Each zone has a different SIA identifier.

- **24 Hr Bell (12):** This zone, when violated, will activate the burglary outputs. This zone will not activate the verbal alarm feature on the PC4936.
- **24 Hr Bell/Buzzer (13):** This zone, when violated, will create an alarm whether the partition is armed or disarmed. However, if the panel is armed, it will activate

the burglary outputs; if disarmed it will activate the keypad buzzer. When the partition is disarmed, this zone will not activate the verbal alarm feature on the PC4936.

- **24 Hr Buzzer (14):** This zone, when violated, will activate the keypad buzzer.
- **24 Hr Technical (15):** This zone is silent.
- **24 Hr Gas (16):** This zone is audible.
- **24 Hr Heat (17):** This zone is pulsed audible.
- **24 Hr Medical (18):** This zone is silent.
- **24 Hr Emergency (19):** This zone is audible.
- **24 Hr Water (20):** This zone is audible.
- **24 Hr Freeze (21):** This zone is audible.
- **24 Hr Holdup (22):** This zone is silent. It does not activate Burglary outputs or the Latched Strobe output.
- **24 Hr Panic (23):** This zone is silent. It does not activate Burglary outputs or the Latched Strobe output.

#### **24Hr Quick Bypass (24)**

Quick Bypass zones are armed at all times. Users can temporarily bypass all Quick Bypass zones on a partition by either pressing the Quick Bypass function key, or entering [\*][6][access code][14].

**NOTE:** It is recommended that the Quick Bypass function key be used.

When a user enters the Quick Bypass command, the zone will be bypassed for the amount of time that was programmed in the **Quick Bypass Duration** section.

If the zone is open when the Quick Bypass Duration timer expires, the panel will begin the **Quick Bypass Pre-alert**. During the pre-alert, the buzzers of all the keypads on the partition will sound.

Users can silence the pre-alert and start the Quick Bypass Duration timer by either entering the Quick Bypass command, or a valid access code.

The zone will be restored at the end of the Quick Bypass Pre-alert time, if it has been closed. If the zone is still open when the pre-alert time expires, the zone will go into alarm. The panel will log the alarm to the event buffer and will transmit the alarm (if programmed), but the alarm will not be recorded in alarm memory ([\*][3] command).

If another Quick Bypass zone is violated during the pre-alert sequence, both zones will go into alarm at the end of the pre-alert period.

If the zone has been bypassed using the [\*][1] menu, the pre-alert will not be triggered and the zone will not go into alarm when it is violated.

When you program any zone on a partition as 24Hr Quick Bypass, you should also program these partition times:

#### **Quick Bypass Duration**

Ref#: [0100XX0206] where XX = Partition 01-08

Program the amount of time (seconds) that 24Hr Quick Bypass zones on the partition will remain bypassed when a user enters a quick bypass command.

#### **Quick Bypass Pre-alert**

Ref#: [0100XX0207] where XX = Partition 01-08

Program the amount of time (seconds) that the pre-alert will sound when the zone is violated.

**NOTE:** If you assign a Quick Bypass zone to more than one partition, then the quick bypass duration and pre-alert times must be the same on each of the partitions.

#### **Latching 24 Hr (25)**

When violated, this zone will operate the same as the 24 hour bell zone (12) with one exception: the installer's mode ([\*][8]) must be entered before the system can be armed. The keypad display will read 'Arming Inhibited Call for Service'. This is to ensure that the problem will be examined by the installer.

#### **Momentary Arm (26)**

A momentary closure of this zone will alternately arm and disarm the partition. This zone can be used with a key-switch to arm and disarm the system.

**NOTE:** This zone type must not be used as a global zone. If a keyswitch zone has been tampered or faulted, the zone must be restored before it can be used to arm or disarm the system.

#### **Maintained Arm (27)**

When this zone is closed, the partition will disarm. When this zone is violated, the partition will be armed. This zone can be used with a keyswitch to arm and disarm the system.

**NOTE:** This zone type must not be used as a global zone. If a keyswitch zone has been tampered or faulted, the zone must be restored before it can be used to arm or disarm the system.

#### **Forced Answer (28)**

When this zone is tripped, the panel will instantly pick up the telephone lines to search for a downloading computer. Do not use this zone type to monitor for alarms.

#### **LINKS Sup (29)**

The LINKS Supervisory zone is used with a LINKS module to monitor for troubles. When the LINKS PGM output activates, a LINKS trouble will be logged on the event buffer and the zone trouble will be transmitted.

**NOTE:** LINKS Supervisory zones always require single EOL resistors regardless of any other programming. Refer to the wiring diagram or Section 2.6 'Specialized Zone Wiring' for zone configuration.

#### **LINKS Answer (30)**

The panel can be uploaded/downloaded via the cellular network. If the LINKS1000 detects an incoming call, it will activate an output which can be used to violate this zone type, forcing the panel to answer the cellular call and begin communicating with the downloading computer.

**NOTE:** LINKS Answer zones always require single EOL resistors regardless of any other programming. Refer to the wiring diagram or Section 2.5 'Zone Wiring' for zone configuration.

#### **AC Delay (31)**

When this zone is violated the panel will begin to count the AC TX Delay time. When this time expires the panel will transmit the General System Trouble event and announce an AC Trouble on all partitions. When the zone is restored the panel will again count the AC TX Delay Time before restoring the trouble and transmitting the General System Trouble Restore event.

**NOTE:** AC Delay zone always requires single EOL resistors regardless of any other programming. Refer to the wiring diagram or Section 2.5 'Zone Wiring' for zone configuration.

**Push To Set Zone Type (32)\***

When a partition to which this zone is assigned is armed, the exit delay for that partition will proceed normally until the end of the exit delay is reached. At that time the exit delay will continue to be annunciated but the partition will not arm. To arm the partition the Push To Set Zone must be violated and restored. Upon momentary violation of this zone, any exit delay active for the partitions to which the zone is assigned will be terminated.

**NOTE:** This zone type should not be programmed as global.

**Function Key Zone (33)**

The Function Key Zone definition, when selected, causes the panel to prompt the function key list and allow the installer to select the following list of functions:

(00) Null Key	(09) Command O/P 2	(18) Fire Reset**
(01) Stay Arm	(10) Command O/P 3	(19) Fire Drill
(02) Away Arm	(11) Command O/P 4	(20) Lamp Test
(03) No-entry Arm	(12) Command O/P 5	(21) Fire Insp Tst
(04) Chime On/Off	(13) Command O/P 6	(22) Quick Bypass
(05) System Test	(14) Command O/P 7	(23) Music Input
(06) Quick Exit	(15) Command O/P 8	(24) Maid's Code
(07) Arm Interior	(16) Silence Trouble	(25) Cancel Key
(08) Command O/P 1	(17) Silence Bells	

When this zone is violated the panel will perform the appropriate function for the partition to which the zone is assigned. No access code is required. Tamper, Faults, or Device Faults on the zone will not cause the panel to perform the respective function (even if Tamper/Fault Opens Zone is enabled). The installer should ensure that the method provided to activate this zone provides sufficient security for the function being performed.

**NOTE:** The zone attributes of this zone type should never be used. This zone type should not be programmed as global.

**Zone Attributes**

The following is a description of each zone option. Scroll through each option and press [\*] to toggle between on and off. When all necessary changes are made, press [#] to return to the previous menu.

Each zone type has different attributes enabled by default. For a list of these default settings, see the *Programming Worksheets*.

- **Bell Audible** – This will determine whether the zone will activate bell outputs and PGM outputs programmed to sound fire/burglary alarms when an alarm occurs. Select [Y] for audible, [N] for silent.
- **Bell Pulsed** – This will determine how the bell outputs and PGM outputs programmed to sound fire/burglary alarms will sound for an alarm. Select [Y] for pulsed, [N] for steady.
- **Bypass Enable** – This will allow the zone to be manually bypassed. Select [Y] to allow bypassing by the user, [N] to prevent it. This attribute should not be enabled for Fire zones.

- **Chime Function** – If the door chime option is enabled, keypad will chime both when the zone is violated and restored. Select [Y] for chime, [N] for no chime. To activate/deactivate the Door Chime feature for a partition, enter [\*][4] at a keypad.

- **Force Arm** – When force arming is enabled, the partition(s) the zone is assigned to can be armed even if the zone is not secure. The zone will be temporarily bypassed and will be added back into the system if it is later restored. Select [Y] to enable this feature. If [N] is selected, the zone must be secured or manually bypassed before arming will be allowed.

- **Swgr Shut Down** – Swinger shutdown. After the zone has reported the programmed number of alarms, the zone will be shut down. Swinger shutdown is reset every time the panel is armed, or when the clock reaches midnight. See 10.5 'Swinger Shutdown'. Select [Y] to enable this feature. If [N] is selected, the panel will always transmit when an alarm occurs.

- **TX Delay** – Transmission delay. When the zone goes into alarm, the panel will sound the bell outputs immediately but will delay communication to the central station for the programmed amount of time. If the zone is disarmed before this time expires, no transmission is sent. If not, the panel will transmit the alarm after the delay expires.

Select [Y] to enable this feature. If [N] is selected, the panel will communicate immediately. To program the Transmission Delay, see 10.9 'Transmission Delay'

- **Waterflow Del** – This will enable the waterflow delay for waterflow zones. Waterflow delay operates similar to transmission delay except both the fire output and communications will be delayed. If the zone is restored before the programmable delay time, no transmission is sent.

Select [Y] to enable this feature. If [N] is selected, the panel will immediately activate the fire output and communicate to central station.

- **Non-Latch Toggle** - Waterflow and Supervisory Zones When the panel is used for pure supervisory/waterflow reporting - no alarm bells - the waterflow and supervisory zone type is non-latching. When the panel is used as a local fire panel and sounds local fire alarm horns for evacuation, these zones types must be latching.

The following two options address these requirements: Waterflow Latch, Fire Sup Latch.

**Zone 1 Fast Loop Response**

If the option Zone 1 Fast (ref # [000200]) is enabled, Zone 1 will have a loop response time of 32ms. If the option is disabled, Zone 1 will have a normal loop response time (512ms). The option is disabled by default.

\* Do not use in UL Listed installation.

\*\* Use only in conjunction with a device UL Listed for fire.

# Section 6: Keypad Operation

---

## 6.1 Partition Keypads

A partition keypad is a keypad that can access one partition. You can assign a keypad to a partition when you enroll it (see 4.1 'Enrolling Keypads and Modules'), or in the Partition Assignment section (see below).

The partition keypad will primarily control the partition to which it is assigned. However, a user will also be able to control other partitions from the partition keypad, if that user's access code allows it.

When a user enters their code to disarm the partition at a partition keypad, the partition to which the keypad is assigned will disarm. The user will then have the option to enter their code again to disarm the other partitions enabled for their code.

### Partition Assignment

To change the partition assignment of a keypad:

1. Enter reference number [0012XX00], where XX = the keypad number.
2. Enter the number of the partition you want the keypad assigned to: (01) - (08), or (00) for Global assignment.

### Partition Toggle Options

Partition keypads can be programmed to operate according to the following options. To program these toggle options, enter reference number [0100XX01] where XX = partition number. Press [\*] to toggle each option ON or OFF. The programming will affect all keypads assigned to the selected partition.

- **Display Clock** - If enabled, the partition keypad(s) will display the time and date when not in use (default=Yes).
- **Display Clock While Stay Armed** - If enabled, the partition keypad(s) will display the time and date when stay armed.
- **Disp Exit Time** - If enabled, the partition keypad(s) will display the exit delay time during the exit delay (default=Yes).
- **System Alarms** - If enabled, the partition keypad(s) will display 'Partition X in Alarm' and will beep (five seconds on; five seconds off) when any other partition is in alarm. This notification will end when the alarm is cleared or when any key is pressed on the partition keypad (default=No).
- **System Status** - If enabled, the partition keypad(s) will display the status (Ready, Not ready, Armed, alarm memory!, Force armed) of all active partitions on the system. If disabled, the partition keypads will not display partition status. This option overrides the clock display option (default=No).

The operation and functionality of the Fire, Auxiliary and Panic keys are also programmable for partition keypads. For more information regarding the FAP keys, see 6.6 'Fire, Auxiliary and Panic Keys'.

## 6.2 Global Keypads

Unlike a partition keypad, a global keypad is not assigned to a single partition. Rather, a global keypad can be used

to access all partitions on the system. You can assign a keypad to be global when you enroll it (see 4.1 'Enrolling Keypads and Modules'), or in the Partition Assignment section (ref # [0015XX00]).

Global keypads should be placed in common or global areas of the premises, such as points of entry/exit or reception areas, where the ability to arm and disarm more than one partition at a time is required.

When a user enters their code to disarm a partition at a global keypad, the system will ask the user to select which partitions they wish to disarm. The system will only allow the user to disarm the partitions for which their access code is enabled.

### Global Keypad Options

Global keypads can be programmed to operate according to the following options. To program these toggle options, enter reference number [000200]. Press [\*] to toggle each option ON or OFF. The programming will affect all global keypads.

- **Global Clock:** If enabled, the time and date will be displayed on global keypads when they are not in use (default=Yes).
- **Global Trouble:** If enabled, when a trouble condition is present on the system, the trouble menu can be viewed from global keypads. If disabled, global keypads will not list trouble conditions (default=Yes).
- **Global Alarms:** If enabled, the global keypads will sound the buzzer and display the message '[Partition label] In Alarm' when any partition is in alarm. The keypad buzzer will be silenced and the message will be cleared when the alarm has been restored or any key is pressed on the keypad. If disabled, global keypads will not indicate alarms (default=No).
- **Global Sys Stat:** If enabled, global keypads will display the status (Ready, Not ready, Armed, alarm memory!, Force armed) of all partitions on the system. If disabled, global keypads will not display partition status. This option overrides the clock display option (default=No).
- **Global Entry:** If enabled, global keypads will sound an entry delay for all partitions. If disabled, the entry delay will only be annunciated if all partitions are armed (default=No).

The operation and functionality of the Fire, Auxiliary and Panic keys are also programmable for global keypads. For more information regarding the FAP keys, see 6.6 'Fire, Auxiliary and Panic Keys'.

## 6.3 Keypad Toggle Options

### Entry / Exit Delay Tones

Ref #: [0012XX01], where XX = keypad number

You can turn off the entry and/or exit delay warning tones for each keypad enrolled on the system. The entry/exit delay tones are on by default.

### Function Key Options

Ref #: [0012XX01], where XX = LCD45X1 keypad number

On each keypad, you can program each function key so that users will need to enter an access code before the panel performs the function. To do this, turn on the 'Funct. X Code' toggle option for that key. The default setting is OFF for each key.

**NOTE:** Some function key types will require an access code entry regardless of the programming in this section. See section 6.11 'Function Key Programming' for more information.

## 6.4 Keypad Time-out

Ref #: [00020302]

Both global and partition keypads can be 'loaned' to other partitions on the system. When a user selects another partition, the keypad will display 'Accessing [Partition Label]' and will operate as a partition keypad from the selected partition.

The amount of time that a loaned keypad will wait before returning to its home partition (or, in the case of global keypads, to its global mode) can be programmed. The Keypad Time-out will begin after the last keypress is made. To program the timer, enter reference number [00020302]. Valid entries are from 020-255 seconds. Do not program the Keypad Time-out for less than 020 seconds.

If your users will have access to audio help (using the PC4936 and Escort4580 modules) you should increase the Keypad Time-out setting to 60 seconds or more. This will allow enough time for the system to announce the help messages. The default setting is 020 seconds.

## 6.5 Keypad Blanking

Ref #: [000200]

When the **Keypad Blanking** toggle option is enabled, all partition keypad lights – including the display – will turn off. The keypad lights and display will remain off until a key is pressed. If the **Keypad Blanking Requires Code** option is enabled, the user will be required to enter their access code in order for the keypad lights and display to turn on.



To program these options, enter reference number [000200] and scroll to the following items. Use the [\*] to toggle each option on or off.

- **Kypd Blanking:** Default = No
- **Kypd Blnk Rq Cd:** Default = No

## 6.6 Fire, Auxiliary and Panic Keys

By default, the Fire, Auxiliary and Panic keys are enabled for both partition and global keypads. To send a fire, auxiliary or panic transmission, press and hold the corresponding [F], [A] or [P] keys for two seconds. FAP key alarms will restore at the end of the Bell Cut-off time (see section 10.2 'Bell Circuit Supervision').

On an LCD4503 keypad, the Fire, Auxiliary and Panic keys correspond to the Fire, Medical and Police buttons, respectively.

On an LCD4501 keypad, the FAP keys are represented by ,  and . Press and hold both keys beside each symbol for two seconds to send the transmission.

### Partition Keypad FAPs

Ref#: [0100XX01] where XX = partition number

- **[F] Enabled:** Default = Yes
- **[A] Enabled:** Default = Yes
- **[P] Enabled:** Default = Yes

To disable the [F], [A] or [P] keys on a partition keypad, enter the appropriate reference number. Scroll to the cor-

rect options and press [\*] to toggle each option ON or OFF. The programming will affect all keypads assigned to the selected partition.

**NOTE:** When a partition keypad is loaned to another partition and a fire, auxiliary or panic key is pressed, the fire, auxiliary or panic alarm will be transmitted using the account number for the partition the keypad is assigned to. The account number of the partition the keypad is loaned to will not be sent.

### Global Keypad FAPs

Ref#: [000200]

- **Global [F] Key:** Default = Yes
- **Global [A] Key:** Default = Yes
- **Global [P] Key:** Default = Yes

To disable the [F], [A] or [P] keys on a global keypad, enter the reference number. Scroll to the correct options and press [\*] to toggle each option ON or OFF.

### Fire, Auxiliary and Panic Key Options

Ref #: [000201]

The operation of the Fire, Auxiliary and Panic keys can be customized according to the following options. Each option is individually programmable for the three keys.

To program these options, enter reference number [000201]. Scroll to the following options and press [\*] to toggle each option ON or OFF.

#### [F]/[A]/[P] Activ. Bell

If enabled, the fire or burg bell outputs and PGM outputs programmed to sound fire or burglary alarms will activate when the [F], [A] or [P] key is pressed. (Default: [F] = Yes; [A] = No; [P] = No).

#### [F]/[A]/[P] Pulse Bell

If enabled, the fire or bell outputs and PGM outputs programmed to sound fire or burglary alarms will pulse when the [F], [A] or [P] key is pressed. If disabled, the fire or bell outputs and PGM outputs programmed to sound fire or burglary alarms, will be steady when the [F]/[A]/[P] key is pressed. (Default: [F] = Yes; [A] = No; [P] = No)

#### [F]/[A]/[P] Key Audib.

If enabled, the keypad will beep three times when the [F], [A] or [P] key is pressed. If disabled, the keypad will remain silent. (Default: [F] = Yes; [A] = No; [P] = No)

## 6.7 Keypad Lockout

Ref#: (XX = partition number)

Global Kypd LockRef #: [000200]

Keypad LockoutRef #: [0100XX01]

Total Bad CodesRef #: [00020200]

Lockout DurationRef #: [00020201]

The keypad lockout feature is a security measure that will prevent access codes from being entered at a keypad once the programmed limit of invalid access codes is reached. The user will then be prevented from performing any function for the programmed time. The message 'Keypad Lockout is Active' will be displayed for the lockout duration.

To enable the keypad lockout for global keypads, enter reference number [000200] and scroll to '**Global Kypd Lock**'. Press [\*] to toggle the option ON or OFF (Default = No).

To enable the keypad lockout for partition keypads, enter reference number [0100XX01] where XX = partition number. Scroll to '**Keypad Lockout**'. Press [\*] to toggle the option ON or OFF (Default = No).

The **Total Bad Codes** option programs the number of bad codes a keypad will allow before it locks out the user. To program this item, enter reference number [00020200] fol-

lowed by the number of incorrect codes. Valid entries are from 000-255. The default setting is 005.

The **Lockout Duration** is the length of time during which a keypad will be locked after the number of bad codes is reached. To program the lockout duration, enter reference number [00020201] followed by the lockout time. Valid entries are from 000 to 255 minutes. The default setting is 015.

## 6.8 Keypad Tamper

Ref #: [000200]

Enable this system toggle option if keypad tamper plates are being used.

## 6.9 Alarm Memory Display

Ref #: [000200]

Enable the **Memory Display** system toggle option, to allow users to view zones that have gone into alarm, while the system is armed. Users can view the alarm memory by pressing the [<][>] keys.

When the option is disabled, the alarm memory will only be displayed when the system is disarmed.

## 6.10 Zone Bypass Display

Ref #: [000200]

Enable the **Bypass Display** system toggle option, to allow users to view bypassed zones while the system is armed. Users can view bypassed zones by pressing the [<][>] keys.

When the option is disabled, users will only be able to view bypassed zones using [\*][1] when the system is disarmed.

**NOTE:** *Bypass Display must be disabled on UL listed systems.*

## 6.11 Function Key Programming

There are five function keys on each LCD45X0/45X1 keypad. Each of these keys can be programmed to perform one of the functions described below. Users can activate a function on partition keypads by pressing and holding the appropriate key for two seconds. The default functions are described below:

### [1] 'Home' – Stay Arm

Pressing this key will arm the partition in the Stay mode, meaning that all Stay/Away type zones will be automatically bypassed. Delay type zones will provide entry and exit delay.

The Quick Arm feature must be enabled in order for this key to function as intended (see *Instruction Manual*, section 3.1 'Quick Arm'). If disabled, the user must enter a valid access code after the function key is pressed to arm the partition.

### [2] 'Away' – Away Arm

Pressing this key will arm the partition in the Away mode. All Stay/Away type zones and all other non-bypassed zones will be active at the end of the exit delay. Delay type zones will provide entry and exit delay.

The Quick Arm feature must be enabled in order for this key to function as intended (see *Instruction Manual*, section 3.1 'Quick Arm'). If disabled, the user must enter a valid access code after the function key is pressed to arm the partition.

### [3] 'Chime' – Door Chime On / Off

Pressing this key will toggle the Door Chime feature ON or OFF. One solid beep means that the feature has been

disabled and three short beeps means that it has been enabled.

### [4] 'Reset' – Reset Smoke Detectors

Pressing this key will cause the panel to activate for five seconds all PGM outputs programmed as Command Output Option #2. The Sen. Rst Cmd #2 option must also be enabled before this function key will work (see section 11.2 'Programmable Output Options'). Only detectors assigned to the keypad's partition will be reset. 2-wire smoke detectors connected to a PC4701 module will also be reset.

### [5] 'Exit' – Activate Quick Exit

Pressing this key will cause the panel to activate the Quick Exit feature. This feature must be enabled in order for the function key to operate (see PC4020 Instruction Manual, Section 3.2 'Quick Exit').

### Function Key Options

Ref. # [0012XX02YY], where XX = keypad 01-16 and YY = the function key.

Once you have entered the section for the correct function key, enter the 2-digit number corresponding to the function you want the key to perform. See below for a list of available functions.

You can also program each function key to require an access code entry before the panel will perform the function (see 6.3 'Keypad Toggle Options').

The following is a list of all function key options:

#### Null Key (00)

The key will perform no function when pressed.

#### Stay Arm (01)

Same as described in 'Stay' above.

#### Away Arm (02)

Same as described in 'Away' above.

#### No-Entry Arm (03)

Once this function key is pressed the user must enter a valid access code. The system will arm and remove the entry delay from the system when the exit delay expires.

#### Chime On / Off (04)

Same as described in 'Chime' above.

#### System Test (05)

This function key provides the user with a simple method for testing the system.

#### Bypass Mode (06)

This function key provides the user with a simple method for entering the Bypass Mode. If the **Bypass Requires Code** option is enabled for the partition, the user must enter an access code before zone bypassing can be performed (see section 7.9 'Access Code Options').

#### Trouble Display (07)

This function key provides the user with a simple method for entering the Trouble Display Mode.

#### Alarm Memory (08)

This function key provides the user with a simple method for entering the Alarm Memory Display Mode.

#### User Programming (09)

This function key provides the user with a simple method for programming access codes. Once this key is pressed, the user must enter a valid master code before the panel will allow programming to be performed (see *Instruction Manual*, section 2 'Access Codes').

**User Functions (10)**

This function key provides the user with a simple method for programming user functions. Once this key is pressed, the user must enter a valid access code before the panel will allow user functions to be performed (see *Instruction Manual*, section 3 'System Administration' for information on [\*][6] functions).

**Quick Exit (11)**

Pressing this key will cause the panel to activate the Quick Exit feature. This feature must be enabled in order for the function key to operate (see *Instruction Manual*, Section 3.2 'Quick Exit').

**Arm Interior (12)**

This function key provides the user with a simple method for adding Stay/Away zones back into the system.

**Command Output X (X=1-8) (13-20)**

This function key provides the user with a simple method for activating a PGM Output programmed as Command Output option #1-8 (see 11.3 'Programmable Output Options'). Once this key is pressed, the user may need to enter a valid access code if the **Cmd.Out X Rq Cd** option is enabled for the command output.

**Silence Trouble (21)\***

Pressing this key silences trouble beeps for the partition. If the Trouble Requires Code system toggle option is enabled, the user will be required to enter an access code in order for this function key to work (see 7.9 'Access Code Options').

**Silence Bells (22)\***

Pressing this key followed by entry of a valid access code will silence the partition's fire alarms.

**Fire Reset (23)\***

Pressing this key followed by entry of a valid access code will restore all fire alarms.

**Fire Drill (24)**

Pressing this key followed by entry of a valid access or Master code will initiate the Fire Drill. This is the equivalent of entering [\*][6][Access/Master Code][5].

**Lamp Test (25)**

Pressing this key followed by entry of a valid access or Master code will initiate the Lamp Test. This is the equivalent of entering [\*][6][Access/Master Code][8] (see *Instruction Manual*, section 5.3 'Lamp Test').

**Fire Insp Tst (26)**

Pressing this key followed by the Walk Test Code will initiate the Fire Inspector's Test Mode. This is the equivalent of entering [\*][6][Walk Test Code][4]. If the test mode is already active, pressing this key followed by the Walk Test Code will disable the test ([\*][6][Walk Test Code][5]).

**User Help (27)**

Pressing this key will automatically create a connection between the keypad and the Escort4580. The Escort starts prompting immediately through the Audio Station assigned to the keypad.

The Escort4580 v1.3 must be enrolled and programmed for this to work. Make sure that this function key is *not* programmed to require an access code entry (see 'Function Key Options').

The intercom station must be programmed as 'intercom'.

**Quick Bypass (28)**

Pressing this key, followed by entry of an access code, will bypass all zones on the partition programmed as Quick Bypass for the length of the Quick Bypass Duration. Press this function key again during the Quick Bypass Pre-alert to restart the countdown.

This is the same as entering [\*][6][Access/Master code][14]. See '24Hr Quick Bypass (24)'.

**Music Input (29)**

Pressing this key will turn on the background music (if programmed) on all the audio stations which hear general pages.

**NOTE:** *The Monitor and Music Input cannot be on at the same time. If they are both enabled, the Monitor will take priority and the Music will not be heard.*

**Temporary Code (30)**

Pressing this function key, followed by an access code, will enable/disable temporary codes on the partition assigned to the keypad. The keypad will sound 3 short beeps when temporary codes are enabled on the partition and one long beep when temporary codes are disabled on the partition. The 'T-code' LED on the LCD45XX will be on when temporary codes are active, and off when they are not active. See section 7.3 'Programming Access Codes'.

**Cancel Key (31)**

Pressing this key when the partition is NOT in alarm will:

- Silence troubles (if in normal mode)
- Exit from the current menu

When a user presses this key when the partition is in alarm the panel will:

1. Request a valid access code.
2. Transmit a Cancel code to the central station.
3. Sound 3 beeps on the keypad, display "Alarm Canceled" on the keypad and sound a voice message stating "Alarm Canceled".

**NOTE:** *For this feature to work, make sure that the Alarm Cancel reporting code is programmed (see 'Appendix A: Reporting Codes').*

**NOTE:** *Alarm Cancel does not initiate listen-in.*

**Zone Control (32)**

Pressing this key will cause the programmed zone to be violated. One of zones 121-128 can be assigned to any function key. Do not assign more than one function key to the same zone. Do not use zones assigned to zone control keys for any other purpose.

The panel will follow the same procedure as when the zone is normally violated. The zone will then automatically restore. Zones assigned to zone control keys will not be supervised.

**NOTE:** *Do not assign fire zones (zone types 07-11) to this function key.*

**Arm All (33)**

Attempts to arm all partitions assigned to a specific user in Away mode. If the function key is programmed to not require a code, then the panel will attempt to arm all active partitions. If a partition is not ready to arm, the message 'Unable to arm all partitions' will appear and none of the partitions will be armed. This function key option is only available to system keypads. If code is required then the panel attempts to arm all partitions to which the code is assigned.

\* Not to be used with UL Listed systems

# Section 7: Installer and Access Codes

---

**NOTE:** Security codes should be changed from their default settings to ensure the security of the system. Do not program codes that can be easily guessed.

## 7.1 Installer's Code

Ref #: [000000]

The installer's code must be entered to access the installer's programming mode. The default installer's code is [5555] for the 4-digit option and [555500] for the 6-digit option. Enter a new code using numbers from 0 to 9 only. This code should be changed from the default setting to ensure the security of the system.

### Installer's Lockout

Ref #: [000005]

The Installer's Lockout feature prevents the installer's code and downloading access code from returning to their default settings when a hardware default is performed. Use the [<] [>] keys to scroll to 'Installer Lockout Enable' or 'Disable' and press the [\*] key to select. By default, the option is disabled.

**NOTE:** Panels returned to the manufacturer with the Installer's Lockout feature enabled, and that exhibit no other problems, will be subject to an additional service charge.

### Engineer's Reset

If the system has gone into alarm, whether during the previous armed period or due to a 24hr alarm, the system will not be ready to arm until Installer's programming mode has been entered, or an Engineer's Reset is performed through the DLS software. When an alarm occurs, the system will not return to ready mode (ability to arm is locked out) if the alarm has not been acknowledged and/or silenced within the communications delay. However, if the alarm is acknowledged before the communications delay has expired, no Engineer's Reset is required and the system will return to the ready mode. System troubles (e.g. AC Trouble, Battery Trouble, FTC etc.) do not affect the Engineer's Reset. The requirement for a reset to be done before the partition can be armed will not be cleared by powering down the panel.

Partition keypads will display the following message whenever the Engineer's Reset feature has been activated:

Unable to Arm  
Call for Service

If an Auto-arm attempt is made while the feature is active the panel will log 'Autoarm Canceled Engineer's Reset' along with the normal Autoarm Cancel event.

## 7.2 Installer-Programmed Access Codes

Several high-level access codes can be programmed which will help ensure the security of the system. By default, all access codes are four digits. To program 6-digit codes, see 7.9 'Access Code Options'. Access code programming is explained in detail in section 7.3 "Programming Access Codes".

### Grand Master Code

Ref #: [000001]

The Grand Master code is access code #0001. This code can be used to program other System Master codes. The default setting of this code is [1234] for the 4-digit option and [123456] for the 6-digit option.

### Second Master Code

Ref #: [000002]

The Second Master code can only be changed in this section. This code cannot be altered by the user. This code can be used to program other System Master codes. It may be used as a master key for service people. The default setting of this code is [AAAA] for the 4-digit option and [AAAA00] for the 6-digit option.

### Walk Test Code

Ref #: [000003]

The Walk Test code is used to access the walk test mode [\*] [6] [Walk Test Code]. See the *Instruction Manual* for directions on initiating a walk test. The default setting of this code is [AAAA] for the 4-digit option and [AAAA00] for the 6-digit option.

## 7.3 Programming Access Codes

This section describes four basic aspects of programming an access code:

- Selecting a new access code for programming
- Programming the 4- or 6-digit code
- Programming the user's name to identify the code
- Selecting the partitions the code will be active on

### Selecting a Code

Before you can program a new code, you must select a user number. To do this, perform the following steps:

1. Enter [\*][5] [master code].
2. The display will read:  
Select (0) < >  
User No. Search  
Press [0] or [\*].
3. The display will read:  
Sel. Code (0001) < >  
User 1

User 1 (Access Code 0001) is the System Master Code. Use the right arrow (>) key to scroll to the code you wish to program (for example, access code 0002). Press [\*] to select the code.

4. A code is now selected for programming. The display will read:  
Select (0) < >  
Program Code

This is the **Program Code menu**. Use the right arrow (>) key to scroll through each display in the Program Code menu. Each display pertains to a different aspect of access code programming, including the three listed below. To select any menu item for programming, press [\*].

## Program A New Code

To program the new access code, perform the following:

1. From the Program Code menu, use the arrow keys to scroll to the first message: 'Select (0) Program Code'. Press [0] or [\*] to program the access code.
2. The display will indicate 'Enter Digits' followed by 'AAAA'. This is the default setting for the access code. Enter four or six digits for the new code.
3. The display returns to 'Select (0) Program Code'. The new code has been programmed.

**NOTE:** Do not program access codes that can be easily guessed and will compromise the security of the system (e.g. 1111 or 1234).

## Duplicate Code Toggle

When this toggle option is enabled the system will not allow the programming of duplicate user codes. If a user code is entered that matches any of the other 1500 users, Installer, Second Master, Walk Test or Guard code, an error tone will be generated and the data will not be saved. When this toggle option is enabled the panel will not perform any check for duplicates when codes are programmed.

## Edit User Name

To program the user name for the new access code, perform the following:

1. From the Program Code menu, use the right arrow (>) key to scroll to the following display:

Select (2) < >  
Edit User Name

2. Press [2] or [\*].
3. The display will read 'Program Name'. For access code 0002, the default name will be 'User 2'. Enter the new access code name using the number keys in the following manner:

The letters of the alphabet have been divided up among the 1 to 9 number keys on the keypad as follows:

[1] = A, B, C, 1	[2] = D, E, F, 2	[3] = G, H, I, 3
[4] = J, K, L, 4	[5] = M, N, O, 5	[6] = P, Q, R, 6
[7] = S, T, U, 7	[8] = V, W, X, 8	[9] = Y, Z, 9, 0
[0] = Space		

For example, if you press the [4] key once, the letter 'J' will appear above the cursor on the display. Press the [4] key again, the next letter 'K' will appear, and so on. If a different number key is pressed, the cursor will automatically move to the right one space. To erase a character, use the [<] [>] keys to move the cursor under the character, then press the [0] key. (See "Access Code Label Options" below for other options available when programming user names.)

4. Once the new name has been entered, press [#]. The display will return to 'Select (2) Edit User Name'.

## Access Code Label Options

These options are also available when programming labels. When programming the label, press the [\*] key for the options menu. Use the arrow (< >) keys to scroll through each option. Press the [\*] key to select.

The available options are:

- **Clear Display:** Selecting this option will clear the entire code label.

- **Clear to End:** This will clear the display from the character where the cursor was located to the end of the display.
- **Change Case:** This will toggle the letter entry between uppercase and lowercase letters.
- **ASCII Entry:** This is for entering uncommon characters. Use the arrow (< >) keys to scroll through the available characters. Each character will be displayed along with the corresponding 3-digit ASCII number. If you know the character's 3-digit number, enter it. Press the [\*] key to enter the character into the code label. See Appendix A at the back of this manual for a list of the available ASCII characters.

## Edit Partition Mask

In order for an access code to function, you must program which partitions the code will be active on. If the system only has one partition, you must activate the code for partition 1.

To program partition access for the new access code, perform the following:

1. From the Program Code menu, use the right arrow (>) key to scroll to the following display:

Select (6) < >  
Edit Part. Mask

2. Press [6] or [\*]. The display will read 'Select Toggle < >'. Partition 1 will be displayed, followed by the letter 'N'. This means that Partition 1 is not available for that code. Press [\*] to select Partition 1 (Y). The [\*] key will alternately enable (Y) and disable (N) the partition for the selected code.
3. Use the right arrow (>) key to scroll to the next partition on the system. Press [\*] to enable or disable the partition. Repeat this step for the rest of the partitions on the system until the desired partition access has been granted for the selected code.
4. Press [#] once you have finished programming the partition mask for the code. The display will return to 'Select (6) Edit Part. Mask'.

## Adding User's Telephone Numbers (PC4850 Modules)

If a PC4850 Telephone Entry module is connected, visitors can call users from the building entrance. For this to work you must enter a 12-digit telephone number for each user.

1. Enter [\*][5] followed by a Master code.
2. Locate the access code for the user with one of the code-searching methods (see Section 2.2 'Modifying an Existing Code'). Press [\*] to select.
3. Use the right arrow (>) key to scroll to the following display:

Select (7) < >  
Phone Number

4. Press [7] or [\*].
5. Enter up to 12-digits for the telephone number. Special characters can be added to the telephone number in order to perform designated functions. Press the [\*] key to enter the telephone entry options menu. The five options are as follows:

- **[0] Save:** This can be selected for the telephone number to be stored into the panel's memory, or simply press [#] when finished entering the telephone number.

- [1] **Dial tone search:** This character will force the panel to search for a dial tone at that point in the telephone number. A 'D' on the display represents a dial tone search. A dial tone search is already programmed as the first digit for each telephone number.
- [2] **Pause 2 Seconds:** This will add a 2-second pause to the dialing sequence, represented by the letter 'A' on the display.
- [3] **Pause 4 Seconds:** This will add a 4-second pause to the dialing sequence, represented by the letter 'E' on the display.
- [4] **DTMF [\*]:** This will add an asterisk to the telephone number, represented by a 'B' on the display. The dialer will output the same frequencies as the touch-tone [\*] key. This character is frequently required to disable call waiting.
- [5] **DTMF [#]:** This will add a '#' to the telephone number, represented by the letter 'C' on the display. The dialer will output the same frequencies as the touch-tone [#] key. In some instances, this character is used to disable call waiting.
- [6] When you are finished, press [#].

### Adding Tenant Codes for Users (PC4850 Modules)

You can give visitors the option of entering a 1-4 digit code on the keypad to call a user. To do this, enter the 1-4 digit code for the apartment. If a user knows a visitor is coming, they can give them the tenant code as a faster way to call them. For this to work, the user's telephone number must also be programmed (see section 4.4).

Tenant codes cannot begin with '0'.

- 1. Enter [\*][5] followed by a Master code.
- 2. Locate the access code for the user with one of the code-searching methods (see Section 2.2 'Modifying an Existing Code'). Press [\*] to select.
- 3. Use the right arrow (>) key to scroll to the following display:  
Select (8) < >  
Tenant Code
- 4. Press [8] or [\*].
- 5. Enter up to 4 digits for the tenant code.
- 6. When you are finished, press [#].

### 7.4 Modify An Existing Code

To modify an existing code, you must first search for it using one of two methods: search by user number or by user name.

To search for the code by **user number**, perform the following:

- 1. Enter [\*][5] followed by a Master code.
- 2. The display will read:  
Select (0) for  
User Number Search  
Press [0] or [\*].
- 3. Enter the access code number and press [\*] to continue programming. You can also use the arrow (< >) keys to scroll to the desired number.

To search for the code by **user name**, perform the following:

- 1. Enter [\*][5] followed by a Master code.
- 2. The display will read 'Select (0) for User Number Search'. Use the right arrow (>) key to scroll to the following display:  
Select (1) for  
User Name Search  
Press [1] or [\*].
- 3. The first letter of the access code name using the corresponding number key. For example, for John, enter the letter 'J' by pressing the [4] key once.
- 4. The keypad will display the first available name starting with the selected letter. Use the right arrow (>) key to scroll through subsequent names.
- 5. Once the appropriate user name is displayed, press [\*] to continue programming.

Once the code has been selected, the Program Code menu will be shown. Reprogram the access code, code label or partition access using the steps outlined in "Program A New Code".

### 7.5 Change User Code Options

User code options determine which system features the code will be able to access. The Access User Code Options Table shows all of the available access code options. The table also indicates which options are enabled by default for each type of code.

To change the user options for a code from its default settings, perform the following:

- 1. Enter [\*][5][master code].
- 2. Locate the code using one of the code searching methods (see section 7.3 "Programming Access Codes"). Press [\*] to select.
- 3. Use the right arrow (>) key to scroll to the following display:  
Select (5) < >  
Edit User Opt's  
Press [5] or [\*].
- 4. Use the arrow (< >) keys to scroll through each option. Press [\*] to turn each option on (Y) or off (N).
- 5. When the desired options have been programmed, press [#].

Access Code User Options Table	Default Settings*				
	GM	2M	SM	S	AC
<b>System Master</b> Select this option to program a System Master Code			Yes		
<b>Supervisor</b> Select this option to program a Supervisor code. You must also program the partition mask for this code.			Yes*	Yes	
<b>Arm</b> Allows arming of the assigned partition(s).	Yes	Yes	Yes	Yes	Yes
<b>Disarm</b> Allows disarming of the assigned partition(s).	Yes	Yes	Yes	Yes	Yes
<b>Bypass</b> Allows bypassing of zones on the assigned partition(s).	Yes	Yes	Yes	Yes	Yes
<b>Command Output</b> Allows activation of a [*][7][X] command output when an access code is required. For more information, ask your installer.	Yes	Yes	Yes	Yes	Yes
<b>Duress Pulse</b> Select option for Duress codes only (See "Special Codes")					
<b>One-Time Use</b> Select option for One-Time Use codes only (see "Special Codes")					
<b>Escort4580 Access</b> Allows access to the Escort4580 Audio Assistant, if installed.	Yes	Yes	Yes	Yes	Yes
<b>Global Access</b> Allows use of a Global keypad.	Yes	Yes	Yes	Yes	Yes
<b>Partition Select Menu</b> Allows all accessible partitions to be viewed when the code is entered.	Yes	Yes	Yes	Yes	Yes
<b>Card Valid</b> (For Access Control Systems only. See Section 4.2 "Access Card Programming")	Yes	Yes	Yes	Yes	Yes
<b>Privilege Card</b> (same as previous)	Yes	Yes			
<b>Wait for Prvl</b> (same as previous)					
<b>Silence Fire</b> Allows the user to silence and reset any Fire Alarms on the selected partitions by entering their access code on the partition keypad.	Yes	Yes	Yes	Yes	Yes
<b>Temporary ("Maid's") Code</b> Temporary codes can be turned on or off by partition using the "T-code" function key.					
* Code abbreviations: GM = Grand System Master; 2M = Second Master; SM = System Master; S = Supervisor; AC = Access Code (default).					
The options for the Grand System Master and Second Master codes cannot be changed from their default settings.					
*For the System Master code, the supervisor option changes to Yes after you exit access code programming.					

### 7.6 Delete An Existing Code

An access code may be erased in two parts. First, all data pertaining to the code may be deleted (access code, user options, partition access, etc.). The access code label is erased separately.

To delete all access code data from an existing code, perform the following:

1. Enter [\*][5][master code].
2. Locate the code using one of the code-searching methods (see section 7.4 "Modify An Existing Code"). Press [\*] to select.
3. Use the right arrow (>) key to scroll to the following display:  
 Select (1) < >  
 Erase Data
4. Press [1] or [\*]. All data pertaining to the access code, except the access code name, will be erased.

To delete the access code name from an existing code, perform the following:

1. Enter [\*][5][master code].
2. Locate the code using one of the code-searching methods (see section 7.4 "Modify An Existing Code"). Press [\*] to select.

3. Use the right arrow (>) key to scroll to the to 'Select (2) Edit User Name' and press [\*].
4. The display will indicate the current name. Press [\*].
5. The display will read 'Select (0) Clear Display'. Press [\*]. The access code name will be erased.
6. Follow the instructions outlined in section 7.3 "Programming Access Codes" to program a new label, or press [#] until you have exited access code programming.

### 7.7 Special Codes

The following codes are special codes. Selecting the corresponding user option will program each code (see section 7.5 "Change User Code Options").

#### System Master Codes

System Master codes have access to all partitions on the system. These codes can be used to program other access codes, except for other System Master codes. For a list of the other user options that are enabled for this code, see the Access Code User Options Table.

#### Supervisor Codes

The supervisor code can be used to program other access codes that are only to be active on the supervisor's partition. Users with Supervisor codes cannot program other Supervisor codes, or System Master codes. For a list of the other user options that are enabled for this code, see the Access Code User Options Table.

#### Duress Codes

If the 'Duress' user option is enabled, the code will become a Duress code. When this code is entered, the system will send a duress signal to the monitoring station. Make sure that the Arm and Disarm user options are also enabled for this code.

**NOTE:** When disarming with an access card, a duress signal is not reported.

#### One-time Use Codes

If the 'One-time Use' option is enabled, the code will become a One-time Use code. The code can be used to disarm assigned partitions. When a user arms the system using a One-Time Use code, the panel will erase the code once the Exit Delay expires; after this time, the code cannot be used again. Make sure that the Arm and Disarm user options are also enabled for this code.

#### Log Only Codes

A 'Log Only' code will only create an entry in the event buffer when entered at a keypad. Example: a log-only code may be used by a guard to record the time that they checked each area of the premises.

To create a log-only code, disable all the access code options for the code.

#### Temporary Codes

A 'Temporary code' is an access code that can be turned on or off by partition using the 'T-Code' function key. (See 6.11 'Function Key Programming'.) Any code with the temporary code attribute enabled will work this way.

To turn temporary codes on for a partition, press and hold the 'T-Code' function key at a keypad assigned to the partition. Users may need to enter an access code after pressing the 'T-Code' key, depending on how the function keys are programmed.

**NOTE:** This feature must not be used with PC4820 access control.

## 7.8 Guard Code

Ref #: [000004]

The Guard code can only be changed in this section and cannot be altered by the user.

The Guard code can always be used to silence alarms and arm all partitions. The code can only be used to disarm partitions the code is assigned to.

In addition, the Guard code can also be used to bypass zones, activate command outputs and access the [\*][6] System Master Options Menu when the code is active.

The Guard code will be active when any of the following conditions occur:

- While a partition is disarmed
- After arming a partition using the Guard code, the code will remain active for five minutes after the exit delay expires. If the Guard code is not enabled for the armed partition, it will only remain active for the duration of the exit delay.

The Guard Code will become active after the 'Guard Delay' time when any of the following conditions occur. The code will remain active for the 'Guard Duration':

- If an alarm, tamper or fault occurs
- When a trouble occurs (each new trouble restarts the timer)
- When a partition has been force armed

### Guard Delay

Ref #: [00020306]

Program the time delay before the Guard code will become active after one of the conditions described above occurs. Valid entries are from [000] to [255] minutes. If [000] is entered, the code will be active immediately (Default = 000)

### Guard Duration

Ref #: [00020307]

Program the time the Guard code will remain active after one of the conditions described above occurs. Valid entries are from [000] to [255] minutes. If [000] is programmed, the Guard Code will have no end time. (Default = 000)

## 7.9 Access Code Options

Access code options determine how codes are programmed and which functions require an access code entry.

### System Options

Ref #: [000200]

The following system toggle options pertain to the programming and operation of access codes. These options apply to every access code programmed on the system.

- **New Grand Mastr:** If enabled, the user can program the Grand Master code (access code 1) through [\*][5] access code programming. If disabled, the Grand Master code can only be changed via installer's programming (default=Yes).
- **6 Digit Codes:** If enabled, all access codes will be 6-digits, except for the panel ID code and Downloading access code. If disabled, all codes will be 4 digits (default=No).
- **Tbl Req Code:** If enabled, a valid access code must be entered to silence the trouble beeps from a keypad (before the condition is restored). If disabled, any key-press will silence the keypad trouble beeps (default=No).

- **Code Display:** If enabled, access codes will be displayed while they are being programmed. If disabled, access codes digits will be represented by 'X'. (Default = No)

### Partition Options

Ref # [0100XX01] where XX = Partition 01-08

The following access code options are programmed by partition. Only access codes assigned to the selected partition will operate according to the following programmed items.

- **Bypas Req Code** - If enabled, the user will be required to enter an access code in order to bypass a zone on this partition (default=Yes).
- **AutoArm Req Cd** - If enabled, the user must enter an access code during the auto-arm pre-alert period in order to cancel automatic arming. If disabled, pressing any key will cancel auto-arming (see 8.2 'Automatic Arming' (default=No).

**NOTE:** *The Auto Arm Cancellation reporting code, if programmed, will be sent in either case.*

- **Cmd. Out Req Cd** - If enabled, the user will be required to enter an access code to be able to activate any output programmed for [\*][7][X] Command Output. If disabled, no code will be required. There are eight toggle options, one for each of the Command Outputs 1-8. (Default for all = No.)
- **[\*][6] Any Code** - If enabled, any access code can be used to access [\*] [6] user functions. If disabled, only a master code will be able to access these functions (default=No).

### Duplicate Code Toggle

When this toggle option is enabled the system will not allow the programming of duplicate user codes. If a user code is entered that matches any of the other 1500 users, Installer, Second Master, Walk Test or Guard code, an error tone will be generated and the data will not be saved. When this toggle option is enabled the panel will not perform any check for duplicates when codes are programmed.

## 7.10 Access Levels

Ref #: [0100XX05] where XX = Partition 01-08

Access levels allow access codes to be active according to a schedule. Only one access level can be assigned each user. See the *Instruction Manual* 'Access Codes' for details on access code programming.

Up to 61 access levels can be programmed per partition. To program an access level, select the access level number 02-63. Enter the number of the date schedule programmed for the times and days you wish the access level to follow (see 14.1 'Date Schedules').

Access level 00 means that the user will never have access. Access level 01 means that the user will always have access to a given area.

**NOTE:** *Always program System Master codes as access level 01.*

# Section 8: Arming and Disarming

---

## 8.1 Arming and Disarming Options

Ref #: [0100XX01] where XX = Partition 01-08

The following arming and disarming options are programmed by partition.

If the **Bell Squawk** option is enabled, outputs will activate once briefly when the partition is armed and twice when the partition is disarmed. All outputs programmed for 'Fire and Burg,' 'Inv Fire/Burg,' 'Burg Only' or 'Inv Burg Only' will squawk (default=No).

In an attempt to reduce false alarms, the Audible Exit Fault (**Aud. Exit Fault**) toggle option is designed to notify the user of an improper exit when arming the system. In the event that the user fails to close the exit/entry door properly, the system will notify them in two ways: the keypad will emit one continuous beep and the burglary bell outputs will activate. If this occurs, the user must re-enter the premises, enter their access code to disarm the system, and then follow the arming procedure again (default=No).

## 8.2 Automatic Arming

Automatic system arming is accessible by the user or system administrator through the [\*][6] System Functions Menu. Through this menu, the user can set auto arm times, days, select a programmed auto arm or disarm schedule and turn auto-arming on and off.

**NOTE:** *If the system has a Loss of Time trouble, automatic arming and disarming will not work.*

For more information regarding automatic arming, please see the *Instruction Manual* 'Auto Arm Control'.

To program auto-arming schedules for partitions, see 14.4 'Arming/Disarming Schedules'.

### Auto-arming Options

Ref #: [0100XX01] where XX = Partition 01-08

Automatic arming is enabled or disabled for each partition. If the **Auto Arm/Disarm** partition toggle option is enabled for a selected partition, the user will be able to set up auto-arming for that partition (default=Yes).

If the **Autoarm Req Code** toggle option is enabled, the user must enter an access code during the auto arm pre-alert period in order to prevent arming. If disabled, pressing any key will cancel auto-arming. The Auto Arm Cancellation reporting code, if programmed, will be sent in either case (default=No).

If **Autoarm Squawk** toggle option is enabled, the bell output will squawk for one second every 10 seconds during the auto arm pre-alert period. If disabled, the bell will not sound (default=No).

**NOTE:** *Autoarming shall not be used on UL listed systems.*

### Auto-Arm Pre-Alert Period

Ref#: [0100XX0205] where XX = Partition 01-08

When a partition begins auto-arming, all keypads assigned to that partition will sound steady for the programmed pre-alert period. During this time, the partition is not armed and a user can postpone/cancel auto-arming by pressing any key on a partition keypad, or entering their access code, if required. The pre-alert period time can be programmed from 001 to 255 minutes (default = 001).

### Postpone Arm

Ref #: [00020305]

If the **Postpone Arm** time is programmed, the user will not be able to cancel the auto-arm sequence. The user will only be able to postpone auto-arming for the programmed amount of time by pressing a key or entering their access code. Once the timer expires, the auto-arming sequence will begin again. Auto-arming can be postponed multiple times. The panel will continue to attempt auto-arming until it is successful.

**NOTE:** *Disabling the auto-arming feature using the [\*][6] command will not cancel auto-arming once the auto-arming sequence has begun.*

Valid entries for the Postpone Arm time are from 000 to 255 minutes. The default setting is 000 (postpone auto-arming disabled).

# Section 9: Entry and Exit Delay

---

Upon arming, the panel will begin the **Exit Delay**. If the 'Exit Delay Aud' option is enabled, the keypad will beep every second until the exit delay expires (see 9.2 'Entry and Exit Delay Options'). The keypad will beep rapidly for the last 10 seconds of the exit delay to warn the user that the system is about to arm.

Upon entry, if a Delay type zone is violated, the panel will begin an **Entry Delay**. The keypad will emit a steady tone. The keypad will pulse the sounder during the last 10 seconds of the entry delay to warn the user that the system is about to go into alarm.

You can turn off the entry and/or exit delay tones at each keypad. See 6.3 'Keypad Toggle Options'.

## 9.1 Entry and Exit Delay Times

Ref #: [0100XX02] where XX = Partition 01-08

The entry and exit delay times are programmed for each partition. These times will program the length of each delay. Entry Delay, Exit Delay, Auxiliary Entry Delay and Auxiliary Exit Delay. Three digits are required for each entry. The times are programmable from 000 to 255 seconds. The four partition times are as follows:

- **Entry Delay** - The entry delay will begin when a delay type zone is violated (Default = 30 seconds).
- **Exit Delay** - The exit delay will begin when a valid access code is entered to arm the partition (Default = 120 seconds).
- **Auxiliary Entry Delay** - This entry delay will begin when an Auxiliary Delay zone is violated. This delay time must be greater than the standard Entry Delay (Default = 45 seconds).
- **Auxiliary Exit Delay** - This exit delay is for Auxiliary Delay zones. This delay time must be greater than the standard Exit Delay (Default = 120 seconds).

## 9.2 Entry and Exit Delay Options

Ref # [0100XX01] where XX = Partition 01-08

The following exit and entry delay options will determine how the delays will sound. These options are programmed by partition.

- **Exit Delay Aud** - If enabled, the keypad will beep during the exit delay (once per second; twice per second during the last 10 seconds of the delay). If disabled, the keypad will be silent during the exit delay (default=No).
- **Exit Delay Sqk** - If enabled, the burg bell outputs will activate during the exit delay (once per second; twice per second during the last 10 seconds of the delay). If disabled, the outputs will be silent during the exit delay.
- **Entry Urgency** - If enabled, the keypad will beep three times every second during the last 10 seconds of the entry delay (default=No).
- **Entry Squawk** - If enabled, the burg bell outputs will sound during the entry delay (once per second; twice per second during the last 10 seconds of the delay). If disabled, the outputs will be silent during the entry delay (default=No).

- **Exit Del. Term.** - If enabled, the exit delay will reduce to five seconds if a Standard Delay zone is opened and closed during the delay period. The bell squawk and keypad notification will cease upon the restoral of the delay zone. At the end of the delay, the partition will be armed (default=No).

**NOTE:** *The exit delay termination time will be extended to eight seconds for systems with AML loops (over 32 detectors).*

- **Spcl Alm Entry** - If enabled, the panel will sound an alternate entry delay if an alarm memory is present: The keypad sounders will pulse to indicate an alarm in memory. If disabled, the panel will sound the normal entry delay, even if an alarm has occurred during the armed period (default=Yes).
- **Exit Tbl Beep** - If enabled, when the system is armed with any trouble present, the keypad will sound a series of 12 beeps before the exit delay begins. If disabled, there will be no warning beeps when arming to indicate a trouble condition (default=No).

**NOTE:** *If AC Trouble displayed is disabled the annunciation will not occur for AC Trouble.*

- **Push to Set** - If a Push to Set zone is assigned to the partition the exit delay will not be completed until the Push to Set zone is tripped.
- **Extended Exit Delay** - If the exit delay is programmed for 255 seconds then the exit delay will count down normally. It will not expire until a delay zone assigned to the partition is opened and closed. Note that the exit delay termination feature must be enabled and a standard delay zone must be assigned to the partition.

**NOTE:** *Do not use this feature with the PC4820 Door Shunt feature.*

# Section 10: System Programming

---

## 10.1 AC/DC Power Options

Ref # [000200]

The following options are used to determine the power settings for the system. Press [\*] to toggle each option on or off.

- **Power Up Shunt:** If enabled, all zones will be inactive during the first two minutes of power up to prevent causing false alarms (default=Yes).

**NOTE:** Do not disable the Power Up Shunt option if AML devices are used.

- **AC Trouble Displayed:** If enabled, the system keypad will display an AC trouble. If disabled, the AC Trouble will not be included in the system trouble indications (default=Yes).
- **AC Frequency 60 Hz:** Enable this feature if the AC cycles at 60Hz; disable it for a 50Hz cycle. The standard for North America is 60 Hz (default=Yes).
- **AC Inhibits Arming:** If enabled, the system cannot be armed when an AC trouble condition is present on the main panel, PC4204/PC4204CX, PC4702, PC4820 or PC4850. If disabled, the system can be armed with the presence of an AC trouble (default=No).
- **DC Inhibits Arming:** If enabled, the system will not arm when a low battery condition is present on the alarm control panel, the PC4204/PC4204CX, PC4702, PC4820 or the PC4850. If disabled, the system can be armed with the presence of an DC trouble.(Default = No)

**NOTE:** This feature does not apply to wireless devices. If enabled, a battery trouble will not inhibit arming. The control panel and PC4204/PC4204CX/PC4702/PC4820/PC4850 modules will only communicate and log to the event buffer three low battery events per 24 hour period (reset at midnight).

## 10.2 Bell Circuit Supervision

Ref#: [00020300] Bell Cut-off

Ref#: [000200] System (Bell) Options

The **Bell Cut-off time** will determine how long the fire/burg bell outputs will be active when an alarm occurs. Valid entries are from 000-255 minutes. The default setting is 004 minutes.

The following system toggle options items will determine how the fire/burg bell outputs will operate.

- **Bell Shutdown:** If enabled, the burg bell outputs will not activate for a zone that has reached the swinger shutdown limit, if programmed. If disabled, a zone alarm will always activate the burg bell outputs (default=Yes).
- **Fire Timeout:** If enabled, the fire bell outputs will follow the bell time-out. If disabled, the fire bell outputs will remain active until a valid access code is entered to silence the alarm (default=Yes).

- **Bell Delay Timer\*:** After an audible burglary alarm has occurred, the system will delay sounding the bells for the amount of time programmed in this timer. Valid entries are from 000 - 255 minutes. If 000 is programmed, there will be no delay before the bells sound. (Default = 000)

For more information regarding the bell output programming, please see Section 11.1 'Main Panel Outputs'. For information on bell circuit wiring, please see 2.12 'Bell Output Wiring (BELL+ and BELL-)'.

## 10.3 Clock Options

### Set System Time and Date

The System time and date can be programmed by the user and thus are not accessible in the Installer's Programming mode. For instructions on programming the time and date, see the *Instruction Manual* 'Setting the Time and Date'.

### Daylight Savings

Ref #: [00020303]

Program the date on which daylight savings time will begin. The month, day and week are required (where MM = 01-12; D = 1-7 Sunday-Saturday; W = 1-5).

To program daylight savings time to start on the first Sunday in April, enter [0411]. At 2 a.m. on the programmed day, the time will automatically adjust to 3 a.m. daylight savings time. All scheduled events that would have occurred between the hours of 2 and 3 a.m. will not occur for this day.

### Standard Time

Ref #: [00020304]

Program the date on which standard time will begin. The month, day and week are required (where MM = 01-12; D = 1-7 Sunday-Saturday; W = 1-5).

To program standard time to start on the last Sunday in October, enter [1015]. (Sometimes, there are five Sundays in a month. If there are not 5 Sundays in the month, the change to standard time will occur on the 4th Sunday.)

At 2 a.m. on the programmed day, the time will automatically adjust to 1 a.m. standard time. Any scheduled events between 1 and 2 a.m. on this day will occur twice.

### System Clock Options

Ref #: [000200]

The following system options pertain to the system clock. Press [\*] to toggle each option either on or off.

- **Military Time:** If enabled, the clock will display 24 hour time (military time) and date will show as MM/DD/YY. If disabled, the clock will display 12 hour time—with an 'a' for a.m. or 'p' for p.m.—and the date will show as Month/DD/YY. The printed time and date also follows this option (default=No).
- **Crystal Time:** If enabled, the timebase will be the internal crystal oscillator. If disabled, the timebase will be the AC power input. The crystal oscillator should be used for applications with a less reliable AC power source (default=No).

\* Do not use in UL Listed installation.

## Clock Adjust

Ref #: [00020308]

This option is to compensate for any timebase inaccuracy. The panel will replace the last minute of each day with the number of seconds programmed in this section.

For example, if the panel seems to lose nine seconds per day, program this section as [051]. Valid entries are 000-255 seconds. The default value is [060].

**NOTE:** Do not schedule events to occur during the clock adjust time.

## 10.4 Event Messages

The following event messages can be modified from their default settings to suit the user's needs. To enter new labels, enter each character as outlined in Section 5.4 'Zone Programming – Zone Labels'.

These messages will only appear if the 'Special Messages' toggle option is enabled by the end user/system administrator, by entering [\*][6][access code][0][2].

The zone tamper and zone fault messages will be displayed regardless of the [\*][6] Special Messages option setting.

### FAIL TO ARM

Ref #: [000100]

This message will appear on every keypad on a partition when a valid code is entered but the partition is not ready to arm. The message will clear after five seconds.

### ALARM WHEN ARMED

Ref #: [000101]

This message appears when a partition is disarmed after an alarm has occurred. The message will be displayed on all keypads on the partition. The message will clear after five seconds and display the zone(s) that went into alarm.

### 4701 2-W SMOKE

Ref #: [000102]

This is the zone label for the 2-wire smoke zone on the PC4701 fire module.

### 4701 WATERFLOW

Ref #: [000103]

This is the zone label for the waterflow zone on the PC4701 fire module

**NOTE:** If there is more than one of these fire messages to be displayed at once, the messages will scroll one after another. Once any fire alarm has been silenced a message 'Fire Bell Has Been Silenced' will be displayed on the partition and global keypads until the partition is armed.

### ZONE TAMPER

Ref #: [000104]

This message will appear on every partition keypad when a zone using Double EOL supervision exhibits a tamper. The message is displayed while viewing open zones.

### ZONE FAULT

Ref #: [000105]

This message will appear on every partition keypad when a zone fault occurs. The message is displayed while viewing open zones.

### ALTERNATE COMMS

Ref #: [000106]

This message will appear whenever the alternate communication unit is referred to.

## 10.5 Swinger Shutdown

The swinger shutdown feature is designed to prevent a runaway communicator from tying up the central station. Each zone can be programmed to follow, or not follow, the swinger shutdown programming (see 5.4 'Zone Programming'). There are two programming items related to this feature: the **Swinger Limit** and the **Shutdown 24Hrs** communicator toggle option.

### Swinger Limit

Ref #: [00040201]

Enter the number of alarms/tampers/faults the panel will communicate per zone before communications for that zone shut down. Valid entries are from 000 to 255. The default setting of swinger shutdown is 003. Entering 000 in this section will disable swinger shutdown.

### Swinger Shutdown Reset Every 24 Hours

Ref #: [000401]

Scroll to the **Shutdown 24Hrs** option. If the **Shutdown 24Hrs** toggle option is enabled, the swinger shutdown counter will be reset every day at midnight, or when the partition is armed. The swinger shutdown counters keep track of how many alarms have occurred on each zone, shutting them down if they reach their limit. If disabled, the swinger shutdown counters will only be reset when the partition is armed. All zone tamper and zone fault swinger shutdown counters are reset on arming (default=No).

## 10.6 Tampers

Ref #: [000200]

The following system toggle options determine how the panel will interpret zone tamper conditions. Press [\*] to toggle each option on or off.

- **Tamper Inhibit:** If enabled, a tampered zone will always show as open. When this occurs, the user cannot bypass the zone and arm the system until the installer's mode is entered. The message 'Arming Inhibited. Call for Service' will be displayed.
- If disabled, the tamper event will be transmitted but the zone can be bypassed and the system armed (default=No).
- **Device Tmp Dis:** If enabled, tampering of wireless zones will always cause tamper alarms and transmissions whether the system is armed or disarmed. If disabled, wireless zone tampers will create a trouble condition when the system is disarmed. The zone tamper will be logged to the event buffer but no Tamper alarm transmission will occur. The event is only logged and transmitted when the partition is armed (default=Yes).
- **Tmp/Flt Opn Zn:** If enabled, an armed zone of any type that is tampered or faulted will generate an alarm as well as the tamper or fault condition. If disabled, tampers and faults will never cause an alarm condition (default=Yes).

## 10.7 Telephone Line Supervision

Ref #: [000401]

Scroll to the **TLM Enabled** option. The panel will monitor the presence of the telephone line and will indicate a trouble condition if disconnected. If the **TLM Enabled** option is selected, the system will test for telephone line faults. The keypads will indicate any faults detected (default=Yes).

If the **TLM Aud Bell** option is selected, the panel will activate the burg bell outputs when the system is armed with a TLM trouble present; the panel will indicate a TLM trouble at the keypad when the system is disarmed. If the option is disabled, only the keypads will annunciate the trouble, whether the system is armed or disarmed (default=Yes).

The **TLM Tbl Delay** will control the number of telephone line monitoring checks required before a telephone line trouble is generated (Ref #: [00040206]). The panel checks the telephone connection at 10-second intervals. Valid entries are from 003 to 255 checks. The default setting is 003.

## 10.8 Test Transmissions

To ensure that the communication link with the central station is functioning properly, the panel can be programmed to send a test transmission signal.

In order to enable test transmissions, the **Periodic Test** option must be turned on (Ref #: [000401], scroll to option; Default = No). The transmission time of day and the number of days between test transmissions must also be programmed.

### Periodic Tx Days

Ref #: [0004020400]

Enter the number of days between test transmissions. Valid entries are from 001 to 255. The default setting is 001. If the **Test Tx in Min** communicator toggle option is enabled, the 'Periodic Tx Days' counter will be the number of *minutes* between test transmissions (Ref #: [000401] and scroll to option). If disabled, the 'Periodic Tx Days' counter will be the number of *days* between test transmissions (default=No).

### Periodic Tx Time

Ref #: [0004020401]

Enter the time of day the test transmission will be sent. Times are entered using 24 Hour format (HH:MM). The default setting is 00:00 (midnight).

The test transmission reporting codes must also be programmed in order for this feature to function (see 12.7 'Reporting Codes').

## 10.9 Transmission Delay

When transmission delays are programmed, the panel will delay reporting the related event for the number of seconds programmed for the programmed time. The various transmission delays are listed below.

If the **Tx Delay in Min** communicator toggle option is enabled, the transmission delay counters will be programmed in minutes instead of seconds (Ref #: [000401], scroll to option).

**NOTE:** Do not use **Tx Delay in Min** if you need to have a transmission delay of less than 5 minutes. This feature must not be enabled on UL listed systems

## AC Fail Delay

Ref #: [00020310]

The panel will delay the trouble indication on keypads and remote annunciators for the programmed time (000 to 255 min.). This delay is to avoid the annunciation of short-term AC failures. Some jurisdictions may not allow any delay for Fire installations. In this case, the timer should be left at its default setting (000 = disabled).

## AC Fail Tx Delay

Ref #: [00040202]

This panel will delay the transmission of an AC trouble reporting code for the programmed time. Enter the time in hours and minutes, from 0000 to 2359 (HHMM). The default setting is 0700.

## Zone Tx Delay

Ref #: [00040203]

The panel will delay the transmission of a zone alarm reporting code for the programmed number of seconds. Valid entries are from 000 to 255 seconds. The default setting is 000. If the alarm is silenced within the programmed time, no alarm communication will be sent. The Transmission Delay zone toggle option must be enabled for each zone in order for this delay to occur. See 5.4 'Zone Programming'.

## Busy Tone Delay

Ref #: [00040205]

When a busy tone is detected after dialing, the panel will wait for the programmed number of seconds before dialing again. Valid entries are from 000 to 255 seconds. The default setting is 060.

## Dial Attempts #1

Ref #: [00040207]

This is the number of dialing attempts the panel will make for telephone number 1 when attempting to send a signal to the central station. If the panel is unsuccessful after the number of programmed attempts, a Failure to Communicate (FTC) trouble will be generated. Valid entries are from 001 to 255 attempts. The default setting is 010 attempts.

**NOTE:** For UL listed systems, this shall be set to between 005 and 010.

## Dial Attempts #2

Ref #: [00040208]

This is the number of dialing attempts for telephone number 2. See 'Dial Attempts #1' for details.

## Dial Attempts #3

Ref #: [00040209]

This is the number of dialing attempts for telephone number 3. See 'Dial Attempts #1' for details.

## Dialing Delay

Ref #: [00040210]

After a failed attempt to call the central station, this is the amount of time the panel will wait before making the next dialing attempt. Valid entries are from 001 to 255 seconds. The default setting is 020.

## 4164 Low Bat Dly

Ref #: [00040211]

The transmission of a low battery condition to the central station will be delayed for the number of days programmed in this section. Valid entries are from 000 to 255 days. The default setting is 007.

### **Waterflow Delay**

Ref #: [00020311]

This delay is to prevent false alarms due to surges in the sprinkler system. The Maximum delay allowed is 90 seconds. The default is 000 seconds (disabled). The Waterflow Delay must be 90 seconds or less. This delay affects all zones programmed as Waterflow, zone type (10). See 5.4 'Zone Programming'.

### **10.10 Cross Zone (Police Code) Alarm**

Ref#: [00020301] Police Code Timer

Ref#: [00040307] Cross Zone (Police Code) reporting code

The Cross Zone (Police Code) reporting code will be transmitted when two different zones on the same partition go into alarm within the Police Code Time. When the first zone goes into alarm, the panel will send the alarm reporting code and will start the **Police Code Timer**.

If a second zone goes into alarm before the timer expires, the panel will send the second zone alarm and the **Cross Zone (Police Code) reporting code**.

Valid entries for the Police Code Timer are from 000-255 minutes. The default setting is 060.

**NOTE:** For UL listed systems, crossed zones shall overlap 100% in the protection area.

### **10.11 System Label**

Ref #: [0009]

This section allows you to program a label for the security system. The label will be used to log events that do not pertain to any partition (e.g. AC trouble). Program a label up to 14 characters long. Enter each character as outlined in 'Programming System Labels'.

### **10.12 Hourly Print**

Ref #: [000200]

Enable this option to have the system print 'Hourly Printer Test', and the time and date every hour.

# Section 11: Programmable Outputs

---

## 11.1 Main Panel Outputs

The main panel has four programmable outputs: Bell, SAUX+, PGM1 and PGM2. Adding PC4216/PC4204/PC4204CX/PC4702 modules can expand the number of outputs. All outputs can be individually programmed to activate according to any of the programmable output options (listed in Section 11.2 'Programmable Output Options').

### SAUX+ Output

Ref #: [0005]

The SAUX+ output can supply up to 300 mA at 12VDC. It can be programmed as one of the output options (see 11.3 'Programmable Output Options').

The default setting of this output is to provide switched power for 4-wire smoke detectors (output option 39 Command Output #2, enabled for Partition 1 with a 5-second pulse time). When used in this mode, the 12V positive output is switched OFF to reset the smoke detectors by using the [\*][7][2] Command from the keypad ('Reset' function key on LCD4501 keypads).

### Bell Output

Ref #: [0006]

The BELL+ terminal is always 13.8 VDC. The BELL- terminal is normally 12.6 VDC. This voltage difference is required for bell circuit supervision. When the bell output is activated, the panel will switch BELL- to ground.

If the bell output is not being used, connect a 1000 $\Omega$  resistor across the BELL terminals to eliminate a trouble. This output can be programmed for one of the available output options (see 11.3 'Programmable Output Options').

### PGM Outputs

Ref #: [000700] for PGM1

Ref #: [000701] for PGM2

The PGM output terminals (PGM1 and PGM2) energize when activated. If the inverted option is selected, the output will de-energize when activated. Either output can be programmed as one of the available output options (see 11.3 'Programmable Output Options').

The default setting for both outputs is Command Output #1 (option 38), active on partition 1 with a 000 second pulse time.

To program PGM 1 and/or PGM2 for AML devices, see 4.4 'Enrolling AML Devices'. An output programmed for AML use cannot also be assigned an output option.

## 11.2 Programming Programmable Output Options for Modules

Ref #: [000702] for PC4204 modules

Ref #: [000703], [000704] for PC4216 modules

Ref #: [000705] for Escort4580 Automation Items

Ref #: [000707] for PC4702 module

Programming PGM output options for modules works similarly to the programming for PGM1 and PGM2. Refer to the *Installation Instructions* for each module for more information.

The programming for the Escort4580 refers to automation items and not actual output terminals on the module. See the Escort4580 *Installation Manual* for a full description of automation items, and how they work.

## 11.3 Programmable Output Options

There are 59 available options for outputs on the PC4020 v3.3 as well as the PC4204/PC4204CX/4216 output modules. Some options require that you select which partitions will activate the output. Use the [<] [>] keys to scroll through each partition and press [\*] to toggle each partition on and off.

### Fire and Burglary (00)

The output will activate when any fire or burglary alarm occurs on any of the selected partitions.

### Inverted Fire and Burglary (01)

The output will deactivate when any fire or burglary alarm occurs on any of the selected partitions.

### Burglary Only (02)

The output will activate when any burglary alarm occurs on any of the selected partitions.

### Inverted Burglary Only (03)

The output will deactivate when any burglary alarm occurs on any of the selected partitions.

### Fire Only (04)

The output will activate when any fire alarm occurs on any of the selected partitions.

### Inverted Fire Only (05)

The output will deactivate when any fire alarm occurs on any of the selected partitions.

### Arm Status (06)

The output will activate when any of the selected partitions are armed.

### Inverted Arm Status (07)

The output will deactivate when any of the selected partitions are armed.

### Date Schedule (08)

The output will perform according to a selected date schedule. Enter a date schedule number from 02-99. In addition, enter a pulse time from 00-59 seconds. Programming [00] will cause the output to activate for the entire schedule. To program date schedules, see 14.1 'Date Schedules'.

### Latched Strobe (09)

The output will activate when any alarm occurs on any of the selected partitions. The output will stay activated until the partition that caused the alarm is disarmed. If disarmed, the output will stay active until the partition is armed.

### Trouble Output (10)

The output will activate when a trouble condition is present on any of the selected partitions. If a system trouble occurs (e.g. loss of time, TLM trouble), all trouble outputs will activate for all partitions.

### Courtesy Pulse (11)

The output will activate during exit or entry delay and for an additional two minutes on any of the selected partitions. It will also activate upon disarming if the partition is armed without entry delay.

### Chime Follower (12)

The output will activate when the door chime is activated on any of the selected partitions. The output will deactivate when the chime pulse timer expires (see 11.4 'Output Pulse Times').

Door chime activates when a zone with the Chime attribute enabled is opened and activates again when the zone is

closed. In order for the output to activate, the door chime feature must be enabled.

#### **TLM Only (13)**

The output will activate when a telephone line trouble is present.

#### **TLM and Alarm (14)**

The output will activate when a telephone line trouble is present *and* an alarm occurs on any of the selected partitions.

#### **Failure To Communicate (15)**

The output will activate when a Failure to Communicate trouble is present. The output will stay activated until a successful communication is sent to the central station.

#### **Communications Active (16)**

The output will activate while the panel is attempting to communicate with the central station.

#### **Ground Start (17)**

The output will activate for a programmable number of seconds before the panel attempts to communicate with the central station.

**NOTE:** This output will follow the 'Ground Start' PGM pulse time (see 11.4 'Output Pulse Times'). This output must not be used on UL listed systems.

#### **Kissoff Output (18)**

The output will activate for a programmed number of seconds after a successful communication to the central station.

**NOTE:** This output will follow the 'Kissoff Pulse' PGM pulse time (see 11.4 'Output Pulse Times').

#### **Combustion Power (19)**

This output will deactivate when a Combustion reset is performed by the panel.

#### **Ready Status (20)**

The output will activate when all the selected partitions are ready to be armed. If any of the selected partitions are not ready, the output will deactivate.

#### **Zone Alarm (21)**

This output will annunciate when a selected zone has gone into alarm. Any zone can be selected. If the zone goes into alarm, the output will activate. The output will remain active until the partition is armed again.

#### **Zone Follow (22)**

This output will follow a selected zone. Any zone can be selected. If the zone is opened, the output will activate. When the zone is secured, the output will deactivate. When the **Follows + Alarms** system toggle option is enabled, the output will remain active until the partition that the zone belongs to is armed or disarmed (ref #[000200]).

#### **Duress (23)**

This output will activate when a Duress code is used to perform any function.

**NOTE:** This output will follow the Duress pulse timer (see 11.4 'Output Pulse Times').

#### **Buzzer Follow (24)**

This output will activate when any of the following events occur on the selected partitions:

- entry delay
- auto-arm pre-alert
- 24HR buzzer zone alarm
- tampers
- faults
- 24Hr quick bypass pre-alert
- AML supervisory faults
- fire supervisory alarms

#### **Remote Operation (25)**

This option can be activated remotely using downloading, and will remain active until deactivated by the downloading computer.

#### **Exit Follow (26)**

This option will follow the exit delay for the selected partition(s).

#### **Entry Follow (27)**

This output will follow the entry delay for the selected partition(s).

#### **Zone Tamper (28)**

This output will activate when any zone tamper alarm occurs on the selected partitions. It will remain active until the partition is disarmed (alarm silenced) or the bell time-out is reached.

#### **Zone Fault (29)**

This output will activate when any zone fault alarm occurs on the selected partitions. It will remain active until the partition is disarmed (alarm silenced) or the bell time-out is reached.

#### **Zone Tamper Follow (30)**

This output will indicate when a zone goes into a tamper alarm. Any zone can be selected. If the zone is tampered, the output will activate; when the zone is restored, the output will deactivate. When the **Follows + Alarms** system toggle option is enabled, the output will remain active until the partition that the zone belongs to is armed (ref #[000200]).

#### **Zone Fault Follow (31)**

This output will indicate when a zone goes into a fault alarm. Any zone can be selected. If the zone is faulted, the output will activate; when the zone is restored, the output will deactivate. When the **Follows + Alarms** system toggle option is enabled, the output will remain active until the partition that the zone belongs to is armed (ref #[000200]).

#### **Armed Stay Mode (32)**

This output will activate when a selected partition is armed in the Stay mode (i.e. when the partition is armed with Stay/Away zones bypassed).

#### **Armed Away Mode (33)**

This output will activate when a selected partition is armed in the Away mode (i.e. when all Stay/Away zones are active).

#### **2-wire Smoke Alarm (34)**

The output will follow the alarm status on the PC4701 2-wire smoke input, if installed. If the input is in alarm, the output will activate; when the alarm is restored, the output will deactivate.

#### **2-wire Smoke Trouble (35)**

The output will follow the trouble status on the PC4701 2-wire smoke input, if installed. If the input exhibits a trouble, the output will activate; when the trouble is restored, the output will deactivate.

#### **Waterflow Alarm (36)**

The output will follow the alarm status on the PC4701 Waterflow input, if installed. If the input is in alarm, the output will activate; when the alarm is restored, the output will deactivate.

#### **Waterflow Trouble (37)**

The output will follow the trouble status on the PC4701 Waterflow input, if installed. If the input exhibits a trouble, the output will activate; when the trouble is restored, the output will deactivate.

#### **Command Outputs 1-8 (38-45)**

The output will activate when the corresponding [\*] [7] [1-8] command is entered on the selected partition. Enter a pulse time for each output (default = 000 seconds; 005 seconds for Command Output #2). A pulse time of [000] will

allow the output to be toggled on and off using the corresponding [\*] [7] [1-8] command.

**NOTE:** All command outputs will deactivate when you exit installer's mode.

**HINT:** If you program more than one PGM for the same command output (eg. command output 1), make sure that either:

a) the PGMs are enabled for all the same partitions

**OR**

b) the partitions the PGMs are enabled for do not overlap. If the 'Inv Cmd Out #X' system toggle option is enabled, the output will be inverted (i.e. the output will normally be energized, and will de-energize when activated). (Ref # [000200]) By default, this option is only enabled for Command Output #2.

If the 'Sen Rst Cmd#2' partition toggle option is enabled, the output programmed as Command Output 2 will reset all smoke detectors connected to it when activated (Ref # [0100XX01]). The keypad will display the Command Output #2 label while the smoke detectors are resetting. If there is no fire condition present, the smoke detectors will return to normal operation after being reset.

**NOTE:** If you have programmed fire zones on a partition, you should also enable the 'Sen Rst Cmd#2' partition toggle option.

### Command Output Labels

Ref #: [0100XX06YY] where XX = partition number (01-08), YY = command output number (01-08)

Program command output labels in this section. All system display labels are programmed in a similar fashion. For instructions on programming labels, see 5.4 'Zone Programming'.

### Police Output (46)

The output will activate when a Cross Zone/Police Code Alarm reporting code is transmitted for any of the selected partitions. It will remain active until a valid access code is entered on any of the selected partition keypads.

### Holdup (47)

The output will activate when a holdup zone on any of the selected partitions is in alarm. It will remain active until a valid access code is entered on any of the selected partition keypads. A tamper or fault on a holdup zone will not activate the output.

### Fire Zone Tbl. (48)

The output will activate when a fire zone is bypassed, or when a fire zone trouble or fault condition is detected. The output will deactivate when the zone is unbypassed or the trouble/fault is restored.

### Steady Fire (49)

The output will turn on steady upon any alarm from a Fire type zone with the Audible zone attribute enabled.

### Temporal Pattern Fire (50)

The output will follow the standard temporal pattern upon any alarm from a Fire type zone with the Audible zone attribute enabled. The temporal pattern is 0.5s ON, 0.5s OFF two times and then 0.5s ON and 1.5s OFF. This pattern is repeated until the signals are silenced.

**NOTE:** PC4204/PC4204CX/4216 v2.1 or higher is required for this option.

### CSFM Fire (51)

The output will follow the California State Fire Marshal pattern upon an alarm from a Fire type zone with the Audible zone attribute enabled. The CSFM pattern is 10s ON and 5s OFF. This pattern is repeated until the signals are silenced

### Pulsed Fire (52)

The output will activate upon an alarm from a Fire type zone with the Audible zone attribute enabled. The output will pulse ON for 0.5s and OFF for 0.5s. The pulsing will continue until the signals are silenced.

### Fire Strobe (53)

The output will turn on steadily upon an alarm from a Fire type zone with the Audible zone attribute enabled. The output will not turn OFF upon signal silence but only on a successful Fire Reset.

### Ground Fault (54)

The output will activate when the PC4020 v3.3 detects a Ground Fault trouble. The output will deactivate when the trouble is cleared.

### Common Fire Tbl. (55)

The output activates when any of the following troubles is detected by the panel. The output deactivates when the trouble is cleared:

- Any system AC or battery trouble (PC4020 v3.3, PC4820, PC4204/PC4204CX, PC4702, PC4850\*, Alternate Communicator\*)
- Any system communicator trouble (TLM1, TLM2, FTC, LINKS, Alternate Communicator\*)
- Ground Fault trouble

### Bell Trouble (56)

The output will activate for a trouble (open or short) on any supervised system bell output (PC4020 v3.3 or PC4702). The output will deactivate when the trouble is cleared.

### AC Status (57)

The output will be active when AC is present on the PC4020 v3.3 as well as all enrolled modules (PC4204/PC4204CX, PC4820, PC4702, PC4850\*, Alternate Communicator\*). The output will deactivate when an AC Fail trouble condition is generated. This output will follow the 'AC Fail Delay,' if programmed (see 10.9 'Transmission Delay').

### Partition Status Alarm Memory (58)

The output will activate when any of the selected partitions are armed. It will deactivate when all selected partitions are disarmed. If an alarm, tamper or fault occurs on any of the assigned partitions, the output will flash for the remainder of the armed period. If the partition is disarmed, the output will flash until the alarm is acknowledged, or the bell time-out period expires.

### Card Used PGM Type (59)

When this output type is programmed, the panel will prompt the installer to enter the user number that this output will activate for. The output will be active for the amount of time programmed in the Pulse Timer whenever an Access Granted event is sent for that user. If programmed for 000 the output will toggle On/Off depending on its initial state.

### Battery Test Output (60)

Whenever partition one is disarmed the panel will perform a 30-second battery test. During this battery test any PGM output programmed as Battery Test will activate for the duration of the battery test. The output is intended to be used to switch a load onto the battery circuit.

## 11.4 Output Pulse Times

Ref #: [000706XX] where XX = pulse time type 00-03

This section will allow you to select the amount of time the PGM output will remain active after being triggered. Valid entries are from 000 to 255 seconds. The available pulse times are listed below:

**Kissoff Pulse (00)**

Any output programmed for 'Kissoff' can be active from 000 to 255 seconds. The default setting is 003 seconds.

**Ground Start (01)**

Any output programmed for 'Ground Start' can be active from 000 to 255 seconds. The default setting is 000 seconds.

**NOTE:** *The panel will wait until the end of the Ground Start before dialing. This feature must not be used on UL listed systems.*

**Chime Pulse (02)**

Any output programmed for 'Chime Pulse' can be active from 000 to 255 seconds. The default setting is 002 seconds.

**Duress Pulse (03)**

Any output programmed for 'Duress Pulse' can be active from 000 to 255 seconds. The default value is 005 seconds.

**Card Used (04)**

Any output programmed for 'Card Used' can be active from 000 to 254 seconds. The default value is 005 seconds. A pulse time of 000 will cause the output to toggle every time a card is presented.

**NOTE:** *This output will not activate when used with the 'Wait for Privileged Card' feature.*

# Section 12: Communications Programming

---

All options concerning communications can be programmed in the following sections, including telephone numbers, reporting codes, account numbers, communicator toggle options and miscellaneous communicator options.

By default, the **Comm Enabled** toggle option is on to enable communications. To disable communications, enter reference number [000401]. 'Comm Enabled' will appear on the display. Press [\*] to toggle the option to [N]o. If disabled, no reporting codes will be transmitted to the central station. Note that downloading can still be accomplished with the communicator disabled.

## 12.1 Telephone Numbers

Ref #: [000400XX00] where XX = telephone number 00-02

The control panel can call up to three different telephone numbers when reporting any event to a central station. The first telephone number is the control panel's primary number for communicating with the central station. The second and third numbers can be used as backup numbers in case the first or second numbers fail to communicate; the numbers can also be used to communicate to a pager.

**NOTE:** A dial tone search must be included in order for a telephone number to be backed up by the LINKS1000.

To program each telephone number, enter reference number [000400XX] (where XX = [00], [01] or [02] for each of the three telephone numbers).

Enter the communicator telephone number the way you would dial it on a telephone. The maximum number of digits (including dial tone searches and pauses) is 31.

Special characters can be added to the telephone number in order to perform designated functions. Press the [\*] key to enter the telephone entry options menu. The five options are as follows:

- [0] **Save:** This can be selected for the telephone number to be stored into the panel's memory, or simply press [#] when finished entering the telephone number.
- [1] **Dial tone search:** This character will force the panel to search for a dial tone at that point in the telephone number. A 'D' on the display represents a dial tone search. A dial tone search is already programmed as the first digit for each telephone number.
- [2] **Pause 2 Seconds:** This will add a 2-second pause to the dialing sequence, represented by the letter 'A' on the display.
- [3] **Pause 4 Seconds:** This will add a 4-second pause to the dialing sequence, represented by the letter 'E' on the display.
- [4] **DTMF [\*]:** This will add an asterisk to the telephone number, represented by a 'B' on the display. The dialer will output the same frequencies as the touch-tone [\*] key. This character is frequently required to disable call waiting.
- [5] **DTMF [#]:** This will add a '#' to the telephone number, represented by the letter 'C' on the display. The dialer will output the same frequencies as the touch-tone [#] key. In some instances, this character is used to disable call waiting.

## 12.2 Account Numbers

When a reporting code is sent to the central station, a 4 or 6 digit account code is also sent to identify the system or partition to the central station. Each partition has its own account code. The system account code is required for reporting codes that do not pertain to a particular parti-

tion, such as module tampers, global keypad alarms or maintenance reporting codes.

The system uses 4 or 6 digit account codes when the SIA FSK communication format is used. When any other communication format is used, the system only uses the last 4 digits of the account code.

### System Account Code

Ref #: [00040003]

Enter 4 or 6 digits and record them in your Programming Worksheets for future reference. The default system account code is [FFFF] or [FFFFFF].

### Partition Account Codes

Ref #: [0100XX00] where XX = partition number

The partition account code is programmed in the Partition programming section. Enter 4 or 6 digits and record them in your Programming Worksheets for future reference. The default for each partition account code is [FFFF] or [FFFFFF].

## 12.3 Dialing Parameters

### DTMF Attempts

Ref #: [00040200]

This section is used to program the number of attempts using DTMF dialing before switching to pulse dialing. Enter three digits from 000 to 255 attempts. If the DTMF Dialing option is disabled, the panel will always pulse or rotary dial.

## 12.4 Communicator Toggle Options

Ref #: [000401]

The following options determine how the panel will communicate. Use the [\*] key to toggle each option on or off.

- **Communications Enabled:** If disabled, no reporting codes will be transmitted to the central station. Note that downloading can still be accomplished with the communicator disabled (default = Yes).
- **DTMF Dialing:** If enabled, the dialer will use DTMF dialing. The panel can switch to pulse dialing after the programmed number of DTMF dialing attempts have failed. If disabled, the panel will use pulse dialing (default=Yes).
- **Restore on BTO:** If enabled, the panel will send the restoral reporting code when both the zone is restored and the bell has timed out. Note that if the zone is not restored, the restoral will be sent when the partition is disarmed. If disabled, the panel will send the restoral reporting code when the zone is restored (default=Yes).

**NOTE:** DO NOT enable this feature if the following 'Restore on Disarm' option is enabled.

- **Restore on Disarm:** If enabled, the panel will send the restoral reporting code when the partition has been disarmed. The panel will not send another alarm transmission for the zone until the partition is disarmed. If

disabled, the panel will send the restoral immediately when the zone is restored (default=No).

**NOTE:** DO NOT enable this feature if the previous 'Restore on Bell Time Out' option is enabled.

**NOTE:** If Bell Shutdown is to be used, DO NOT enable this option.

- **Shut Down 24HRS:** If enabled, the swinger shutdown counters will be reset every day at midnight, or when the partition is armed. These counters keep track of how many alarms have occurred on each zone, shutting them down if they reach their limit. If disabled, the swinger shutdown counters will only be reset when the partition is armed (default=No).

**NOTE:** This option should be enabled when using global zones.

- **PC ID:** If enabled, the panel will identify all manually bypassed zones when the partition is armed. The partial closing reporting code must be programmed for this feature to work.
- If disabled, the panel will only send a partial closing reporting code to tell the central station that zones were bypassed when the partition was armed (default=No).
- **PC on Auto Arm:** If enabled, the panel will send the partial closing reporting code to the central station when a zone is force armed during auto-arming. If disabled, no partial closing reporting code will be sent (default=Yes).
- **PC ID Restores:** If enabled, the zone restoral reporting codes will be transmitted instead of the zone alarm reporting codes to identify the manually bypassed and force armed zones upon auto-arming. If disabled, the zone alarm reporting codes will be sent (default=No).
- **TLM Enabled:** If enabled, the system will test for telephone line faults. The keypads will indicate any faults detected (default=Yes).
- **TLM Aud Bell:** If enabled, all bells will be audible when a telephone line trouble is present and the partition is armed (default=Yes).
- **FTC Aud Bell:** If enabled, a Failure To Communicate trouble will cause the bell outputs to activate. If disabled, only the keypads will announce the trouble (default=No).
- **TLM + Alarm Aud:** This option will determine whether the burg bell outputs will activate when a Transmission Line Monitoring trouble and an alarm occur simultaneously. If enabled, the bells for the armed partition will sound.
- **Ringback:** If enabled, the partition keypad will beep 10 times when a successful communication of a closing to the central station occurs (default=No).

**NOTE:** If communications are being sent to more than one telephone number, communications to all numbers will produce a ringback.

- **Ringback Sqwk:** If enabled, the partition keypad and the partition bell outputs (Fire/Burg, Inv Fire/Burg, Burg and Invert Burg) will squawk when a successful communication of a closing to the central station occurs (default=No).

**NOTE:** The Ringback option must be enabled in order for this feature to function.

- **Periodic Test:** If enabled, the panel will send a test transmission to the central station (default=No).

If this feature is enabled and a PC4701 module is enrolled on the system, the panel will alternate sending the periodic test transmission between Line 1 and Line 2 of the PC4701 so that both communication paths are tested.

- **Europe Dial:** If enabled, the contact closure to the telephone line is made in a 67/33 make/break ratio. This is the European standard method of dialing (default=No).

**NOTE:** Do not enable this option for North American installations.

- **Default Dial:** With this option enabled, if panel's first attempt to call the central station fails, it will dial on every subsequent attempt regardless of the presence of a dial tone. When disabled, if a 'D' for dial tone search precedes the telephone number, the panel will not dial if dial tone is not present. See 12.1 'Telephone Numbers' for programming the telephone numbers with dial tone search (default=Yes).
- **Ph 1-2 Backup:** If enabled, the panel will attempt to report to the second telephone number if it is unable to communicate using the first telephone number. The panel will attempt to call for the number of times programmed as the Maximum Number of Dialing Attempts. When used as a backup number, the dialer direction options for the second telephone number should be disabled (default=No).
- **Ph 1-3 Backup:** This option is similar to 'Ph 1-2 Backup' except that the panel will backup to the third telephone number instead of the second (default=No).

**NOTE:** If the 'Ph 1-2 Backup' option is also enabled, the reporting code will be sent to both the second and third telephone numbers if the panel is unable to communicate using the first number.

- **Ph 2-3 Backup:** This option is similar to 'Ph 1-2 Backup' except that the panel will attempt to report to the third telephone number if it is unable to communicate using the second telephone number (default=No).

**NOTE:** If the 'Ph 1-2 Backup' option is also enabled, the reporting code will be sent to the second telephone number if the panel is unable to communicate using the first number. If the panel also fails when attempting to call the second telephone number, the panel will send the reporting code to the third number.

- **Busy Tone Det.:** If enabled, when a busy tone is detected for four seconds, the panel will hang-up and wait for the amount of time programmed as the Busy Tone Delay before attempting to redial. If disabled, the panel will not search for busy tone when dialing the telephone number (default=No).

**NOTE:** This feature must not be used with the LINKS1000.

- **1300 Hz ID:** If enabled, the panel emits a 1300Hz identification tone from the time it dials to the time it hears the handshake from the receiver. If disabled, no identification tone is emitted (default=No).

**NOTE:** This option should not be used with Pager 2, Pager 3 or Contact ID formats. This feature should not be used in North America.

- **Alternate Dial:** If enabled, the panel will alternate between the first and second telephone numbers when attempting to call the central station, regardless of the

dialer direction settings. If disabled, the panel will follow the programmed backup dialing procedure (default=No).

- **SIA 1 Account #:** See 12.6 ‘Communicator Formats’ for information.
- **Auto Report SIA:** See 12.6 ‘Communicator Formats’ for information.
- **Test Tx in Min:** If enabled, the test transmission timer will be in minutes. If disabled, it will be in days. See 10.8 ‘Test Transmissions’ (default = No).
- **Tx Delay in Min:** If enabled, the transmission delay will be in minutes. If disabled, it will be in seconds. See 10.9 ‘Transmission Delay’ (default = No).
- **2nd Line Flash:** If enabled, the panel will use the standard dialing routing with the following addition. If the panel doesn’t detect a dial tone during the first five seconds, the panel will flash the line (hang up and pick up again) for 90ms. The panel will then search for a dial tone on the virtual line (default = No).

**NOTE:** This option is for use in Sweden only. Do not enable in North America. If this and the LINKS1000 are enabled, the LINKS dialing procedure will be slightly different. The panel will backup to the LINKS on the third attempt.

- **6 digit Acct:** If enabled, the system and partition account numbers will be six digits for the SIA format. If disabled, the account numbers will be four digits (default=No).
- **T-Link Enabled:** This option must be set to [N] for a UL Listed system. If enabled, a communications link between this product and a receiver, DLS, computer or other devices on a LAN/WAN will be used.

**NOTE:** A T-Link module must be connected to the PC-Link connector on the panel.

Please refer to the T-Link *Installation Manual* for further information.

**12.5 Dialer Direction**

Ref #: [000400XX02] where XX = telephone number 00-02  
 The Dialer Direction programming section determines which reporting codes will be sent to which telephone number. Three groups of reporting codes can be selected:

- alarms and restorals
- openings and closings
- all other miscellaneous codes

These groups can be programmed to communicate to any or all telephone numbers.

By default, all reporting codes are sent to the first telephone number only. The dialer direction options are toggle options which are either enabled ([Y]es) or disabled ([N]o). Dialer options are programmed individually for each telephone number. The reporting codes in each group are indicated in Appendix A ‘Reporting Codes’.

**12.6 Communicator Formats**

Ref #: [000400XX01] where XX = telephone number 00-02  
 Each telephone number must be assigned a format to communicate with the central station. There are several different communicator formats available. The default format is 20 BPS 2300Hz Handshake.

**10 BPS 1400/2300Hz Handshake Formats**

- Data = 1900 Hz
- Kissoff = 1400/2300 Hz
- Speed = 10 Baud

**20 BPS 1400/2300Hz Handshake Formats**

20 Bits Per Second is the standard fast format used on DCI, Franklin, Sescoa and Vertex receivers.

- Data = 1800 Hz
- Kissoff = 1400/2300 Hz
- Speed = 20 Baud

These formats will send an account code to identify which customer is sending the alarm, and a reporting code to identify the type of alarm. Depending on the receiver, the account code must be either three or four digits, and the reporting code must be either one or two digits.

If the account code requires only three digits, program the system ID code and each partition account code with 3 digits, followed by a [0]. If you wish to send a zero in the account code, program it with a HEX A. For example, to program account code 103 enter ‘1A30’.

If the reporting code needs to be only one digit, program the second digit as a [0]. For example, to program a reporting code as ‘3,’ enter ‘30’. To send a zero, program HEX A into the reporting code. For example, to send reporting code ‘30,’ program ‘3A’.

For instructions on programming HEX digits, see 3.4 ‘Programming Hexadecimal Data’.

**Contact ID**

Contact ID is a specialized format that will communicate information using tones rather than pulses. This format allows more information to be sent faster than other formats. For example, in addition to reporting a Zone 1 alarm, the Contact ID format can also report the type of alarm, such as an Entry/Exit alarm.

To program Contact ID, a 2-digit number from Appendix A must be entered for every event to be transmitted. The 2-digit number determines the type of alarm. The panel will automatically generate all other information, including the zone number.

**Additional Notes on Contact ID**

1. Account Numbers must be four digits.
2. All reporting codes must be two digits.
3. Substitute the HEX digit ‘A’ for the zero (0).
4. To prevent the panel from reporting an event, the reporting code should be programmed as [00] or [FF].

Please refer to Appendix A ‘Reporting Codes’ and Appendix B ‘Zone Reporting Codes’ for a list of suggested Contact ID Identifiers for each event.

**Auto-Contact ID**

Ref #: [000401] and scroll to option

When programmed, the Auto-Contact ID automatically generates the Contact ID reporting codes for all events. Program [00] to disable the event from reporting.

**NOTE:** Several fire related reporting codes are set to 99 by default to ensure they are transmitted. If using Contact ID, these code need to be reprogrammed. See Appendix A for the specific codes.

### Contact ID Identifier Toggle Options

- **Partial Closing Identifier:** This toggle option controls whether the Partial Closing reporting code will be transmitted with an identifier of 4 or 5 when using Contact ID.
- **Opening After Alarm Identifier:** This toggle option controls whether the Opening After Alarm reporting code will be transmitted with an identifier of 4 or 5 when using Contact ID.

### SIA FSK

SIA is a specialized format that will communicate information quickly using Frequency Shift Keying (FSK) rather than pulses. The SIA format will automatically generate the type of signal being transmitted, such as Burglary, Fire, Panic etc. The 2-digit reporting code is used to identify the zone or user code number.

**NOTE:** If you use a communication format other than Automatic SIA for any of the backup telephone numbers, make sure that the appropriate reporting codes are programmed.

### AutoRep SIA

Ref #: [000401] and scroll to option

If the SIA format is selected, the panel can be programmed to automatically generate all zone and user code numbers, thus eliminating the need to program these items.

If the 'AutoRep SIA' toggle option is enabled, the panel will operate as follows:

1. If an event's reporting code is programmed as [00], the panel will not attempt to call the central station.
2. If the reporting code for an event is programmed as anything from [01] to [FF], the panel will *automatically* generate the zone or user code number.

The Communicator Call Direction options can be used to disable the reporting of events such as openings and closings.

If the 'AutoRep SIA' toggle option is disabled, the panel will operate as follows:

1. If an event's reporting code is programmed as [00] or [FF], the panel will not attempt to call central station.
2. If the reporting code for an event is programmed as anything from [01] to [FE], the panel will send the programmed reporting code.

For Communicator Toggle Option programming, please see 12.4 'Communicator Toggle Options'.

### Zone Label Sent with Events

With this feature the installer can choose to have the zone label transmitted along with the zone event, when using SIA. When this option is enabled, whenever the panel transmits an event which identifies the zone number it will transmit the programmed label for that zone number immediately after the zone event. All fourteen characters of the label will be transmitted even if the programmed label is less than 14 characters.

The panel will do this by sending an asterisk before and after the label.

**NOTE:** Installer must ensure that this feature is supported by the central station receiver(s).

### SIA 1 Account#

Ref #: [000401] and scroll to option

If the 'SIA 1 Account#' toggle option is enabled, the SIA communication format will send the system ID code along with the partition number with each data transmission. If disabled, the communication format will use all eight Par-

tion ID codes to identify partition events. If this option is enabled, partition account numbers are not required.

Please refer to Appendix A 'Reporting Codes' and Appendix B 'Zone Reporting Codes for a list of SIA identifiers.

### SIA Transmission 4-Digit Option

This option controls whether the panel will transmit three or four digits for the reporting code when using SIA. Four digits are required to properly identify users 1000-1500. Otherwise these users will be identified as 999.

**NOTE:** Before choosing this option, you must ensure that this feature is supported by the central station receiver(s).

### Pager Formats

The Pager format can be used for latchkey operation to notify a parent when a child comes home from school or to notify a key holder that an alarm has occurred. In North America, the Pager Format 3 should be used.

When programming the Pager telephone number, special programming is required in order for the panel to transmit the page successfully. Pauses, [\*] key presses and [#] key presses may be required. For more information about programming these special items, see 5.1 'Zone Supervision'. The panel will only make one attempt to send a page for each event. There are three types of pager formats:

- **Pager Format 1** (Semadigit) transmits seven DTMF digits for each event. Each round transmits a 4-digit account code followed by a 2-digit reporting code followed by the DTMF Character [#]. Only one event is communicated per call. This format requires an initial handshake of 440Hz and a kissoff handshake of 1400Hz.

**NOTE:** Do not use this format in North America.

- **Pager Format 2** (Semaphone) transmits no data. The system will call the number programmed once for every event that occurs. This format is intended to be used with a pager but can be used to call a private residence. This format will sound the line every two seconds after dialing the telephone number. Although events are not identified, the recipient is made aware of an alarm. Only one event is communicated per call. No handshake or kissoff signals are required for this format.

**NOTE:** Do not use this format in North America. Do not use this format with 1300 Hz ID.

- **Pager Format 3** is similar to Pager Format 1 except that no handshake or kissoff signals are required.

**NOTE:** Do not use this format with 1300 Hz ID. UL has only verified compatibility of the PC4020 v3.3 with the Silent Knight model 9000, Ademco model 685, Linear model 3060 and Radionics model D6500.

## 12.7 Reporting Codes

Reporting codes must be programmed in order for the panel to report events to the central station.

Reporting codes are two digits and can use hexadecimal digits A through F. Some communicator formats only require one digit (see Section 12.6 'Communicator Formats'). To disable a reporting code, program it with 'FF' (default setting) or '00'. Pressing the [\*] key when entering the code will call up a menu for hex digit entry. For instructions on programming HEX digits, see 3.4 'Programming Hexadecimal Data'.

All reporting codes are listed and described in Appendix A 'Reporting Codes'.

# Section 13: Downloading

---

**NOTE:** DLS-3 v1.3 or higher is required. Downloading is not to be enabled on UL Listed systems.

## 13.1 Downloading Options

### Automatic Upload of Event Buffer when %75 full

Ref #: [000300]

This option allows the installer to choose if the panel will automatically call the downloading computer when the Event Buffer %75 full event occurs. This option is independent of the actual transmission of the Event Buffer %75 full event (the event does not need to be transmitted for the panel to perform the automatic upload). The panel will first transmit the Event Buffer %75 full event (if enabled) and then perform the automatic download.

### Downloading Telephone Number

Ref #: [000302]

Enter the telephone number for the downloading computer (only applies if the User Call Up, Periodic DLS, or DLS Callback option is enabled). For instructions on programming telephone numbers, see 12.1 'Telephone Numbers'.

### Panel ID Code

Ref #: [000303]

The 4-digit panel identifier code will identify the panel to the downloading computer. The panel ID code must be different for each panel if either User Call Up, Periodic DLS or DLS Callback is used. The default setting is 4921.

### Panel Downloading Access Code

Ref #: [000304]

This 4-digit code must be programmed the same as the downloading access code in the computer file. If the codes are different, the panel will NOT allow any uploading or downloading to take place. The code is used to help ensure the security of the system. The default setting is 4920.

### Double Call Timer

Ref #: [000305]

This is the maximum time between two telephone calls when the 'Double Call' option has been enabled. Valid entries are between 000 and 255 seconds. The default setting is 060 (see 'Downloading Toggle Options – Double Call' below to enable the Double Call feature).

### Number of Rings

Ref #: [000306]

This is the number of consecutive rings the panel must detect before answering the call for downloading. Valid entries are between 001 and 255 rings. The default setting is 008.

### Downloading Toggle Options

Ref #: [000300]

Downloading to the panel is not enabled by default. Select one or more of the following options to allow the computer to communicate with the control panel. Use the [\*] key to toggle between [Y]es and [N]o to enable or disable each option. Use the [<][>] keys to scroll through the available options.

- **DLS Enabled:** If enabled, the panel will answer an incoming call for downloading after the programmed number of rings. The panel can also be programmed to answer using the double call feature (see 'Double Call'

in this section). If disabled, the panel will not answer any incoming calls (default=No).

- **User Call Up:** If enabled, the user can make the panel call a remote computer by entering the [\*][6][Master Code][12] User Call Up command (default=No).
- **Double Call:** If enabled, the panel will follow the double call procedure. If the panel detects one or two rings on the first call and then is called again within a programmed time, the panel will answer the second call on the first ring. To program the Double Call Timer, see 'Downloading Options – Double Call Timer' above. If disabled, the panel will only answer after the programmed number of rings (default=No).
- **DLS Callback:** If enabled, both the computer and the panel will hang up after a connection is made. The computer will then wait for the panel to call. If disabled, the downloading computer will have immediate access to the control panel once accepted as valid (default=No).

**NOTE:** If more than one computer is used for downloading, callback should be disabled.

- **Periodic DLS:** This feature can be used to have the panel periodically call the downloading computer. Upload/download commands programmed in advance (batch files) will be executed. See 13.2 'Periodic Call-up' for programming the time and days when this will occur. The computer must be waiting for a call in order for this feature to work (default=No).
- **User Enabs DLS:** If enabled, the user will be able to activate the ring detect feature for 60 minutes in order to allow downloading to occur. If the DLS Enabled option is on, this option will not apply (default=No).

## 13.2 Periodic Call-up

Ref #: [000301]

This option programs the time and number of days between periodic downloads:

- **Periodic TX Days (00):** Program the number of days between periodic downloads. Valid entries are from 001 to 255 days. The default setting is 030.
- **Periodic TX Time (01):** Program, in military time, the time of day the panel will call the computer for periodic downloading. The default setting is 00:00 (midnight).

## 13.3 PC-Link

Ref #: [000307]

The PC-Link is an adapter that connects the control panel to a computer to provide on-site downloading. With the PC-Link, no modem is required. The time that is required to complete a successful download is significantly reduced. A serial cable is used to link the computer with the control panel.

For instructions on using the PC-Link, please consult your DLS-3 Software Manual ('Connecting Via PC-Link').

# Section 14: Event Scheduling

---

Event scheduling allows for a variety of timed events to occur on specific dates and at specific times. Openings and closings can be suppressed during high traffic times, outputs may be programmed to follow date schedules and partitions may be auto-armed and auto-disarmed at specific times

## 14.1 Date Schedules

Ref #: [001001]

The panel uses date schedules to control the period during which an event will occur. There are 99 date schedules, each containing four intervals. Date schedules are used by open/close suppression schedules, holiday groups, arming/disarming schedules and output schedules (see 11.3 'Programmable Output Options').

To disable a date schedule, set all the days of the week and all the holiday groups to N.

**NOTE:** Date schedules 00 and 01 are special purpose schedules used to control events for the PC4820 Access Control module. For information regarding these schedules, see the PC4820 Installation Manual.

### Interval Programming

Ref #: [001001XXYY] where [XX = date schedule 02-99] and [YY = interval 01-04]

Every date schedule contains four intervals. Each interval contains the time and days that the schedule will be active. Intervals also contain holiday groups as well as automatic arming/disarming options. The following items can be programmed for each interval:

#### Set Start Time

Program the time of day that the schedule interval will start (HHMM). The default time is 0000 (midnight). Valid entries are 0000-2359 and 9999 (no start time). If two intervals in a schedule are programmed for the same start time, the schedule will follow the interval with the longest end time.

#### Set End Time

Program the time of day that the schedule interval will end (HHMM). The default time is 0000 (midnight). Valid entries are 0000-2359 and 9999 (no end time).

#### Select Toggles

The following toggle options are available for each interval. Select either [Y]es or [N]o for each option by pressing the [\*] key. The default for each option is No (off).

- **Sunday-Saturday:** Select on which days of the week the interval will be active.
- **Holiday 1-4:** Select the holiday group(s) that the interval is to follow. See 14.2 'Holiday Groups' for holiday programming.
- **Auto-arm:** Select whether the interval will be used to automatically arm any partition(s) selected by the arming and disarming schedule. See 14.4 'Arming/Disarming Schedules' for auto-arm programming.
- **Auto-disarm:** Select whether the interval will be used to automatically disarm any partition(s) selected by the arming and disarming schedule. See 14.4 'Arming/Disarming Schedules' for auto-disarm programming.

**NOTE:** Do not program an interval with both auto-arming and auto-disarming enabled. In order for these features to work, they must be programmed as separate intervals

### Activating Outputs for Less than One Minute

When programming an output to activate for less than one minute, program the output's pulse time between 01

and 59 seconds. The output will remain active for the number of seconds programmed. If the pulse time is programmed as 00, the output will remain active until the end time of the interval (see 11.3 'Programmable Output Options').

### Activating Outputs for Longer than One Day

If a schedule is required to extend past 24 hours, two intervals will be required. Program the start time of the first interval and select the day of the week on which the schedule should start. Program the end time of the first interval *and* the start time of the second interval as [9999]. Program the end time of the second interval and select the day of the week on which the schedule should end.

### Activating Schedules on Specific Days

You may have an application that requires a schedule to only be active on holidays. Program an interval with the desired start and end time. Select [N] for every day of the week. Select [Y] for the correct holiday group. Normally, the schedule will never activate except on the holidays programmed in the selected holiday group.

**NOTE:** To properly disable an interval, you must return all of the interval settings to the default state.

## 14.2 Holiday Groups

Ref #: [001002]

Holiday Groups allow for days when scheduled events should not occur. There are four Holiday Groups. Up to two years of dates can be programmed per holiday schedule.

To program a holiday schedule, select the Holiday Group from 1 to 4 and the display will read 'Enter Date'. Enter the month, day and year—this year or next—as a 6-digit entry (MMDDYY). Once the date has been entered, the keypad will beep and another date can be entered using the same format. Use the [<] [>] keys to scroll through the programmed dates. To erase a selected date, press the [\*] key when the date is displayed on the keypad. Once a holiday has occurred, the holiday will be erased from the panel's memory.

Holiday Groups 1-4 can be enabled for any interval of any Date schedule.

**NOTE:** The system time and date (including year) must be set before holiday schedule programming can begin.

## 14.3 Open/Close Suppression

Ref #: [001000]

Open/Close Suppression will prevent the communication of openings or closings for the partitions following a programmed date schedule. When an Open/Close Suppression schedule is active, openings or closings for the selected partitions will be logged to the event buffer but no transmission will be made to the central station.

There are 99 Open/Close Suppression Schedules. Each is capable of suppressing openings or closings for the selected Partitions, but not both. To suppress openings AND closings, two separate Open/Close Suppression schedules must be programmed.

The following options are programmable for each Open/Close Suppression schedule:

### Open/Close Suppression Toggle

If the Open/Close Suppression schedule is being used to suppress openings, toggle this option to [Y]. If it is to suppress closings, toggle this option to [N].

### Date Schedule

Enter the 2-digit number of the date schedule that will be used to suppress openings or closings.

### Partition Toggle

For the partitions that are to have the openings or closings suppressed, toggle the option to [Y]

**NOTE:** *Regardless of opening suppression, when a partition is disarmed with alarms in memory, the opening and opening after alarm reporting code will be reported, if programmed.*

## 14.4 Arming/Disarming Schedules

Ref #: [001003]

Arming/disarming schedules are used to auto arm or auto disarm partition(s) according to the selected date schedule. There are 50 Arm/Disarm schedules.

The following options are programmable for each Arm/Disarm schedule:

### Date Schedule

Enter the two digit number of the Date schedule that will be used to auto arm/disarm.

Enter Schedule [02]-[99]. Do not use schedules 00 or 01. If these schedules are used, the arm/disarm schedule will never activate.

### Partition Toggle

Toggle the option to [Y] for the partitions that are to auto arm or auto disarm.

Programming Date Schedule Intervals for Auto Arm/Disarm

1. Program the time to auto arm or auto disarm as the Start time for an interval. Program the End time as one minute after the Start time. For example, to auto arm or auto disarm at 8 a.m., program the Start time as 0800 and the End time as 0801.
2. Select [Y] for the days of the week the partitions will auto arm or auto disarm.
3. If the panel is not supposed to auto arm or auto disarm on certain days, select [Y] for any Holiday Group the schedule is to follow.
4. Finally, toggle the Auto Arm or Auto Disarm toggle option, depending on which function the panel should perform.

**NOTE:** *Each interval can be used for either auto-arming or auto-disarming, but not both.*

In order for an arming/disarming schedule to function on a partition, the following toggle options must be enabled:

- A Date schedule must be programmed with auto-arm or auto-disarm enabled.
- Partition toggle option 'Auto-Arm /Disarm' must be enabled.
- User function toggle option 'Auto-Arm' must be enabled. This option has no effect on the 'Scheduled Disarm' toggle option. To disable a scheduled disarm, only 'Scheduled Disarm' has to be disabled.
- User function toggle option 'Scheduled Arm' or 'Scheduled Disarm' must be enabled.

## 14.5 Scheduled AMS-220/220T Smoke Detector Test

AML smoke detectors continuously monitor themselves for low sensitivity and will report this condition as a device trouble. In addition, this test can be conducted automatically on a programmed schedule.

There are 50 smoke test schedules. Each smoke test schedule is assigned a date schedule. To schedule the AML smoke detector test, perform the following:

1. Enter reference number [001402] and press [\*].
2. The keypad display will read 'Select Entry # / Enter 01-50'. Use the arrow (< >) keys to select which Smoke Test schedule is to be programmed and press [\*].
2. The keypad display will read 'Enter Sch.# / Enter 00-99'. Enter the date schedule you have programmed for the smoke test (valid entries are 02-99). The default date schedule for each smoke test schedule is 01 (disabled).
3. The keypad display will read 'Select Toggle Partition X'. Use the arrow (< >) keys to scroll through each partition and press the [\*] key to toggle them on (Y) or off (N). This will activate the smoke test at the programmed time for only the selected partitions. By default, no partition is selected (N).

When programming a date schedule, program the time to perform the AML smoke test as the Start time for an interval. Program the end time as one minute after the start time. For example, to perform a smoke test at 8 a.m., program the Start time as 0800 and the End time as 0801.

**NOTE:** *A different schedule must be programmed for each partition. Each test must be programmed to occur at least 10 minutes apart.*

# Section 15: LINKS Communications

---

## 15.1 LINKS1000 (Cellular Communications)

When using a LINKS1000 Cellular Communicator as a primary or backup means of communicating to the central station, the following sections must be programmed. For instructions on programming telephone numbers, please refer to Section 12.1 "Telephone Numbers".

### LINKS1000 Telephone Numbers (00-02)

Ref #: [000404XX] where XX = 00-02 (telephone numbers 1-3)

The three LINKS telephone numbers will be used when the landline telephone numbers fail to communicate. LINKS telephone number 1 will back up the first telephone number, LINKS 2 the second and LINKS 3 the third.

**NOTE:** A Dial Tone Search must be included in the land telephone number. See 12.1 "Telephone Numbers" for details.

### DLS Number (03)

Ref #: [00040403]

This number is used if downloading is to be performed or backed up by the LINKS1000. Enter the telephone number for the downloading computer if the User Call Up, Periodic DLS or DLS Callback features have been enabled.

### LINKS1000 Toggle Options

Ref #: [00040404]

- **LINKS1000 Enable/Disable:** This option must be enabled when using a LINKS1000 (default=No).

**NOTE:** Once the Links module is selected, the main PGM output automatically changes to LINKS Operation and cannot be reprogrammed.

- **LINKS Test Transmission:** If enabled, the panel will send a test transmission for the LINKS unit to the central station (default=No).

### LINKS Transmission Cycle

Ref #: [00040405]

Enter the number of days between LINKS test code communications. Valid entries are from 001 to 255. The default setting is 030.

### LINKS Transmission Cycle Time

Ref #: [00040406]

Enter the time of day the LINKS test code will be communicated. Times are entered using military format (HH:MM). The default setting is 0000 (midnight).

**NOTE:** Do not program the system to send the LINKS test transmission and the Periodic test transmission at the same time.

## 15.2 LINKS2XXX (Long-range Radio Communications)

Ref #: [000405]

The following four toggle options are to be programmed only when using a LINKS2150/2450 Long-Range Transmitter.

- **LINKS2XXX Enable/Disable:** This option must be enabled when using a LINKS2150 (default=No).

**NOTE:** The 'Communications Enabled' communicator toggle option must be enabled in order for the LINKS2150 to communicate (see 12.4 "Communicator Toggle Options").

- **Alarms/Restore:** If enabled, the LINKS2150 will report alarms and restores. See 12.5 "Dialer Direction" for more information (default=No).

- **Open/Close:** If enabled, the LINKS2150 will report openings and closings. See 12.5 "Dialer Direction" for more information (default=No).

- **All Others:** If enabled, the LINKS2150 will report all other events to the central station. See 12.5 "Dialer Direction" for more information (default=No).

**NOTE:** To disable the main panel communicator but still have events communicated through the LINKS2XXX, disable the dialer directions for all three telephone numbers.

**NOTE:** Zones programmed to follow the transmission delay time will not be delayed when the system transmits events using the LINKS2XXX.

## 15.3 T-Link TCP/IP Communications)

The T-Link module can be used as a backup or primary communicator. The T-link can also be used as a secondary or primary downloading source. The T-link module uses a TCP/IP network on a LAN\WAN to communicate to a receiver or DLS-3 software. The module is connected to the PC-Link header on the PC4020A board.

**NOTE:** PC-LINK and T-Link cannot be used at the same time.

The following sections must be programmed for T-Link communications.

The T-Link uses the same telephone numbers as the Landline communicator refer to Section 12.1 "Telephone numbers". Any phone number that the T-Link uses must be programmed with 'CAAA', to program this, remove the dial tone search 'D' and enter [\*5] [\*2] [\*2] [\*2] in the phone number area.

The T-Link option must also be enabled in the communicator toggle options refer to Section 12.4 (t-link enabled)

If downloading is used with the T-Link you must program the system as stated in Section 13 "Downloading".

The T-Link will not connect with DLS via User Call-up, DLS call back or periodic DLS. The downloading connection must be established from the computer without call-back enabled.

# Section 16: Diagnostics and Troubleshooting

## 16.1 General Diagnostics

Ref #: [04]

The diagnostics function is designed to help you track down any problems with the installed modules.

If there is no problem the keypad will display 'PC40X0 System No Faults Found'.

If there is a problem, the keypad will display 'Error... Module'. This message will be accompanied by either 'E' 'T' or 'LV' followed by a number. The number represents the module (see list below). The letters represent the following:

- E = communications error. The main panel has lost communications with the module.
- T = tamper. The tamper zone on the module has been activated.
- LV = low voltage. The module is not receiving enough voltage from the Combus.

Below is a list of the indicated numbers and which modules they represent.

### Indicated #Module #

1-8	For Future Use
9-24	LCD45XX - #1-16
25-28	PC440X - #1-3
29-44	PC41XX - #1-16
45-53	PC4216 - #1-9
54-69	PC4204/PC4204CX - #1-16
70	Not used
71	ESCORT4580
72-87	PC4820 - #1-16
88	PC4701
89-92	PC4702 #1-4
93	PC4936
94-109	PC4850 #1-16
110	Alt. Comms

## 16.2 Restoring Factory Default Programming

These options are only available during the first 10 minutes after power up. To access these sections, disconnect then reconnect the AC and battery power. Then, enter [\*] [8] [Installer's Code], followed by reference number [0402] to default the main panel, or [0403] to default the ESCORT4580 (if installed).

### Factory Default (Software)

Ref #: [0402]

Once this selection has been made, the keypad will read 'Confirm Default Press \*'. Press the [\*] key to confirm the operation. To cancel the default, press the [#] key.

Once the [\*] key is pressed, the programming keypad will display the message 'Power System Down and Restart'. Remove the battery and AC connections to the control panel. This will erase all programming and reset the system to its factory default settings. All modules will have to be re-enrolled.

When using AML devices, the AML Key will return to [00] upon resetting the panel's software.

### Default ESCORT4580 (if installed)

Ref #: [0403]

Once this selection has been made, the keypad will read 'Confirm Default Press \*'. Press the [\*] key to confirm the operation. To cancel the default, press the [#] key.

Once the [\*] key is pressed, the programming keypad will display the message 'Resetting 4580 Module'. Once the default is complete, the keypad will display '4580 Default is Complete'. The ESCORT4580 module will be reset to its factory default settings.

## 16.3 Hardware Reset

If the installer's code is lost inadvertently, the only way to reprogram the system is to perform a hardware reset.

**NOTE:** If the Installer's Lockout feature is enabled, there is no way to reprogram the system without entering the correct installer's code. Panels returned to the manufacturer with this feature enabled and exhibiting no other problems will be subject to an additional service charge.

**NOTE:** Delete any enrolled AML zones from the system before performing a Hardware Reset.

To reset the panel to its factory default settings, perform the following:

1. Power the system down by removing both the AC connections and the battery power to the control panel.
2. Short the Z1 and PGM1 terminals on the control panel. Nothing else should be connected to Z1 or to the PGM terminals.
3. Restore power to the control panel. Wait for 20 seconds.
4. Power down the panel by removing both the AC and battery connections.
5. Remove the short between the Z1 and PGM1 terminals. The system will have reloaded all factory default settings. All modules will have to be enrolled again. The event buffer is the only part of the system's memory that will not be restored.
6. Power up the panel. Connect the battery first, then the AC.

## 16.4 Viewing Trouble Conditions

The alarm control panel continuously monitors a number of possible trouble conditions. If one of these conditions occurs, the keypad Trouble light will turn on and a beeping sound will be heard every 10 seconds. Press the [#] key to silence the keypad. The Trouble light will stay on until the trouble is cleared.

If the Audible AC Tbl option is turned on (ref # [000200]), keypads will sound trouble beeps at the end of the AC Fail Delay (see 10.9 'Transmission Delay') when the panel loses AC power. If the option is turned off, keypads will not sound trouble beeps when the panel loses AC power. The option is off by default.

If the Latch Troubles option is turned on (ref # [000200]), whenever any panel or module AC or battery trouble

occurs, the panel will not restore the trouble until it has been viewed using the [\*][2] trouble display. The trouble will not be restored until it has been viewed, even if the cause of the trouble has been physically restored. If the option is turned off, the panel will restore these troubles as soon as the trouble condition is physically restored. The option is off by default.

Trouble conditions can be transmitted to the central station, if programmed (see 12.7 'Reporting Codes').

To view trouble conditions, press the [\*] key then [2]. The keypad display will indicate the trouble. All possible trouble displays and a description of each are listed below.

Display	Trouble Condition
Battery Trouble	The battery connected to the control panel is low.
AC Trouble	There is a power failure (keypad will be silent).
Aux Supply Troub	The AUX, SAUX+ or PGM terminals on the alarm control panel are overloaded
TLM Trouble	There is a trouble with the telephone line.
TLM TBL Line #1	There is a trouble on telephone line 1 (only generated when using the PC4701 Fire Module).
TLM TBL Line #2	There is a trouble on telephone line 2 (only generated when using the PC4701 Fire Module).
FTC Trouble	The alarm control panel can no longer communicate with the central monitoring station. The trouble is generated after the programmed failed communication attempts. If a later attempt to communicate is successful, the trouble is cleared.
Bell CCT Trouble	The bell circuit is open (PC4020 or PC4702).
Fire Trouble	A fire loop is open (indicated by the trouble sound; cannot be silenced). If the alarm control panel loses communication with any expansion module, all Fire/Burglary outputs will activate once every 10 seconds until a keypress is made, or module communication is restored.
2 Wire Smoke	The fire zone on a PC4701 Fire Module is open. The keypad will display '2-Wire Smoke' until the trouble is restored.
Ground Fault	The earth ground (EGND) connection is shorted to a positive voltage source or shorted to a non-earth ground potential.
Waterflow	The Waterflow zone on a PC4701 Fire Module is open. The keypad will display 'Waterflow TBL' until the zone trouble is restored.
Loss of Time	This trouble is cleared when the system's time and date are reset.
Module Com Fault	The panel has lost communications with a module. Check to see if the module is connected properly, then do a system reset. Only qualified service personnel can perform this function.
Combus Low Pwr	Modules are not getting enough voltage from the Combus. Check for proper connection of Combus, or reposer the Combus, if required. Only qualified service personnel can perform this function.
4204 Battery TBL	The battery connected to any PC4204/PC4204CX relay output module is low (module number indicated in reporting code transmission and event buffer).
4204 AC Trouble	A PC4204/PC4204CX relay output module loses incoming AC power (keypad will be silent).

## 16.5 System Fault Squawk

If the **Sys.Flt.Squawk** option is turned on, when the system detects a zone tamper, zone fault or a module tamper, all the burglary bell outputs will squawk once every 5 seconds. The 'squawks' will be silenced when the alarm is silenced or a key is pressed on that partition. By default this option is off.

Display	Trouble Condition
4204 AUX Trouble	The Auxiliary supply on any PC4204/PC4204CX relay module is overloaded.
LINKS Trouble	A LINKS unit has one or more of the following trouble conditions: loss of AC power, low battery, loss of cellular communication or a tamper fault.
DLS Fault TBL	The control panel has failed to complete communications with the downloading computer.
Device Fault	A wireless zone has failed to report a zone supervisory (press [*] to view which zone).
Device Low Batt	A wireless zone has a low battery (press [*] to view which zone/device).
Device Tamper	A wireless zone has a tamper condition (press [*] to view which zone).
Automation Fault	The ESCORT4580 loses communication with the Automation Output control module. If there is an AC trouble present, the panel will not transmit the Automation Fault reporting code to the central station.
4820 Battery Trouble	The battery connected to a PC4820 module is low.
4820 AC Trouble	A PC4820 module has lost AC power.
4820 Lock Trouble	A PC4820 module has a trouble with one of its locking devices. A lock trouble occurs when the lock power output is overloaded or the lock power fuse has failed.
4820 Aux Trouble	The PC4820's Auxiliary (AUX) supply is overloaded.
4820 Rdr Pw TBL	A PC4820 module's card reader power output is overloaded or the reader power fuse has failed.
Smoke Low Sens	A WLS906 Smoke Detector's sensitivity is low.
4164 Signal Tbl	Wireless zone transmissions are not being received by a PC4164 wireless receiver.
RF Jam Detected	Wireless device transmissions not being received by a PC4164 wireless receiver
4702 AC TBL	The PC4702 module has lost AC power.
4702 Battery TBL	The battery connected to the PC4702 is low.
Bells Silenced	Fire alarm signals have been silenced. Trouble will clear when the system is reset (enter access code).
Insp. Test Active	The fire inspector's test has been initiated. Trouble will clear when the test mode is disabled.
Printer Off-Line	The printer connected to the PC440X module is off-line.
DVAC Trouble	The DVACS line from central station is not present, the module has failed internal diagnostics or DVACS communications have been shut down.
DataLink	The DataLink application connected to the PC4401 module is off-line.
4850 Battery TBL	The battery connected to a PC4850 module is low.
4850 AC Trouble	A PC4850 module has lost AC power.
4850 AUX Trouble	The PC4850's Auxiliary (AUX) supply is overloaded.

<b>Display</b>	<b>Trouble Condition</b>
Alt. Comms AC Trouble	The alternate communicator has lost AC power.
Alt. Comms Battery TBL	The battery connected to an alternate communicator module is low.
Alt. Comms FTC Trouble	The alarm control panel can no longer communicate with the central monitoring station. The trouble is generated after the programmed failed communication attempts. If a later attempt to communicate is successful, the trouble is cleared.
Alt. Comms Remote Shutdown	The alternate communicator has been disabled by the central station.
Alt. Comms Encrypt Disabled	
Alt. Comms General TX TBL	One of the following conditions has occurred: <ul style="list-style-type: none"> <li>• Radio not responding</li> <li>• Not connected to central station</li> <li>• No service</li> <li>• Unstable signal</li> </ul>
Alt. Comms TBL XX	An unidentified trouble has occurred, XX is the trouble number. Please see the appropriate alternate communicator manual for details.
Alt. Comms Low Signal XX	The received signal strength is low, XX is the signal strength.
T-Link Network Fault	A communication problem has occurred between the T-Link and the network.
T-Link Receiver Trouble	When the T-Link module cannot communicate with the receiver on the TCP/IP network.
T-Link Communications Fault	When the T-Link module cannot communicate with the PC4020 on the PC-Link connection.

# Appendix A: Reporting Codes

## Notes on Contact ID

The following is a list of Contact ID reporting codes. The first digit (in parentheses) will automatically be sent by the control. The last two digits are programmed to indicate specific information about the signal.

For example, if zone 1 is an entry/exit point, the alarm reporting code could be programmed as [34]. The central station would receive the following:

### \*BURG - ENTRY/EXIT - 1

In the above example, the '1' indicates the zone in alarm.

### Notes on SIA Format

If the **SIA 1 Account #** option is selected, the panel will send the system account code along with its data trans-

mission (ref # [000401], scroll to option). At the receiver, the transmission would look similar to this example:

```
N Ri01 / BA 001
N      = New Event
Ri01   = Partition / Area Identifier
BA     = Burglary Alarm
001    = Zone 1
```

### 4-Digit Reporting Codes

When using 4-digit reporting codes a leading zero will be added to all reporting codes except for the user numbers (0000 to 1500).

Ref. #	Reporting Code	Code Sent When...	Dialer Direction*	Contact ID	SIA Auto Rep Codes**
[00040300]	Zone Alarms	zone goes into alarm	A/R	see Appendix B 'Zone Reporting Codes'	
[00040301]	Zone Restorals	alarm condition has been restored	A/R		
[00040302]	Zone Trouble/Tamper	zone exhibits a trouble/tamper condition	A/R		
[00040303]	Zone Trouble/Tamper Rest.	trouble/tamper condition has cleared	A/R		
[00040304]	Zone Fault	zone exhibits a zone fault	A/R		
[00040305]	Zone Fault Rest.	zone fault condition has cleared	A/R		
[00040306]	[F] Key Alarm/Rest.	Keypad fire alarm (alarm and restore rep. codes sent together)	A/R	(1) 15	FA-000/FH-000
[00040306]	[A] Key Alarm/Rest.	Keypad auxiliary alarm (alarm and restore rep. codes sent together)	A/R	(1) AA	MA-000/MH-000
[00040306]	[P] Key Alarm/Rest.	Keypad panic alarm (alarm and restore rep. codes sent together)	A/R	(1) 2A	PA-000/PH-000
[00040307]	Duress Alarm	Duress code entered	A/R	(1) 21	HA-000
[00040307]	Opening After Alarm	partition disarmed with alarm in memory	A/R	(4/5) 58	OR-000
[00040307]	Recent Closing	alarm occurs within two minutes of partition arming	A/R	(4) 59	CR-000
[00040307]	Cross Zone (Police Code) Alarm	two zones on the same partition go into alarm within the Police Code Time during any given armed period (incl. 24Hr zones)	A/R	(1) 39	BV-000
[00040307]	Door Forced Alarm/Rest.	(access control) door forced open alarm event occurs (PC4820 only)	A/R	(1) NONE	DF-ZZZ/DR-ZZZ
[00040307]	Door Open Too Long Alarm/Rest.	(access control) door open too long events occur (PC4820 only)	A/R	(1) NONE	DN-ZZZ/DH-ZZZ
[00040307]	Alarm Cancel	a user presses the Cancel function key after the partition has gone into alarm	A/R	(4) A6	BC-UUU
[00040308]	General System Tamper/Rest.	enrolled module with tamper inputs has a tamper alarm	O	(1) 45	TA-000/TR-000
[00040309]	Keypad Lockout	max. number of incorrect access codes has been entered at a keypad	O	(4) 21	JA-000
[00040309]	2-wire Alarm/Rest.	2-wire smoke alarm (PC4701 only)	A/R	(1) 11	FA-999/FH-999
[00040309]	Waterflow Alarm/Rest.	waterflow zone alarm (PC4701 only)	A/R	(1) 13	SA-998/SH-998
[00040309]	2-wire Trouble/Rest.	2-wire smoke zone has a trouble (open) condition (PC4701 only)	A/R	(3) 73	FT-999/FJ-999

\* A/R = alarms/restorals; O/C = openings/closings; O = other

\*\* PPP = partition number; UUU = user number (user 1000 to 1500 = 999); ZZZ = zone number

Ref. #	Reporting Code	Code Sent When...	Dialer Direction*	Contact ID	SIA Auto Rep Codes**
[00040309]	Waterflow Trouble/Rest.	waterflow zone has trouble (open) condition (PC4701 only)	A/R	(3) 73	ST-998/SJ-998
[00040309]	Fire Test Begin	fire inspector's test start & fire drill test begins	A/R	(6) A4	FI-000
[00040309]	Fire Test End	fire inspector's test end & fire drill test ends	A/R	(6) A4	FK-000
[00040309]	Fire Bypass/Unbypass	fire zone bypassed/unbypassed	A/R	(5) 71	FB-ZZZ/FU-ZZZ
[00040310]	User Closings	partition armed (user 001-128 indicated)	O/C	(4) A2	CL-UUU
[00040311]	Closing 129-1500	user code # 129-1500 used to arm partition	O/C	(4) A2	CL-UUU
[00040311]	Special Closing		O/C	(4) A2	CL-000
[00040311]	Partial Closing	one or more zones intentionally bypassed when partition armed	O/C	(4/5) 56	CW-000
[00040311]	Automatic (Scheduled) Closing	auto arming according to schedule	O/C	(4) A3	CA-000
[00040311]	Auto Arm Cancellation	auto arm cancelled	O/C	(4) A5	CE-000
[00040312]	Partition Closing	partition armed (partition number indicated)	O/C	(4) AA	CG-PPP
[00040313]	User Openings	partition disarmed (user 001-128 indicated)	O/C	(4) A2	OP-UUU
[00040314]	Opening 129-1500	user code # 129-1500 used to disarm partition	O/C	(4) A2	OP-UUU
[00040314]	Special Opening	disarm with WLS909, Second Master code, keyswitch, downloading or guard code	O/C	(4) A2	OP-000
[00040314]	Automatic (Scheduled) Opening	auto disarming according to schedule	O/C	(4) A3	OA-000
[00040314]	Door Shunt	PC4820 zone shunted while armed	O/C	(5) 76	DG-222
[00040315]	Partition Opening	partition disarmed (partition number indicated)	O/C	(4) AA	OG-PPP
[00040316]	Battery Trouble/Rest.	PC4020 battery is low	O	(3) A2	YT-000/YR-000
[00040316]	AC Line Trouble/Rest.	AC power to control panel is disconnected or interrupted	O	(3) A1	AT-000/AR-000
[00040316]	Panel Bell Trouble/Rest.	open circuit detected across bell terminals	O	(3) 21	YA-000/YH-000
[00040316]	Panel Auxiliary Trouble/Rest.	aux voltage supply trouble	O	(3) AA	YP-000/YQ-000
[00040316]	Combus Trouble/Rest.	control panel loses communications with connected module(s) or has low power	O	(3) 33	UT-000/UJ-000
[00040316]	TLM Failure/Rest.	telephone line 1 monitoring trouble (sent via LINKS. Do not program if LINKS not used)	O	(3) 51	LT-001/LR-001
[00040316]	TLM Line2 Failure/Rest.	telephone line 2 monitoring trouble (sent via LINKS. Do not program if LINKS not used)	O	(3) 52	LT-002/LR-002
[00040316]	FTC Restoral	control panel has restored communications to central station (after TLM Fail)	O	(3) 54	YK-000
[00040316]	Buffer Near Full	printer not used or off-line for 450 events	O	(3) None	JL-000
[00040316]	User System Test	[*][6] bell/communications test	O	(6) A1	RX-000
[00040316]	Periodic Test	periodic test transmission	O	(6) A2	RP-000
[00040316]	Periodic Test Tbl	periodic test transmission trouble	O	(6) A7	RP-001
[00040316]	LINKS Test	LINKS test transmission	O	(6) A3	TX-000
[00040316]	Ground Fault/Rest.	EGND connection detects a ground fault	O	(3) 1A	US-000/UR-000
[00040316]	DLS Lead In	DLS Call Back feature only: downloading session start	O	(4) 11	RB-000
[00040316]	DLS Lead Out	DLS Call Back feature only: downloading session complete	O	(4) 12	RS-000
[00040316]	Installer Lead In	Installer code has been entered	O	(4) 58	LB-000
[00040316]	Installer Lead Out	Installer's programming complete	O	(4) 58	LS-000

\* A/R = alarms/restorals; O/C = openings/closings; O = other  
\*\* PPP = partition number; UUU = user number (user 1000 to 1500 = 999); ZZZ = zone number

Ref. #	Reporting Code	Code Sent When...	Dialer Direction*	Contact ID	SIA Auto Rep Codes**
[00040316]	Closing Delinquency	programmed number of days for delinquency has expired without partition being armed	O	(4) 54	CD-000
[00040316]	Walk Test Enabled	walk test mode entered	O	(6) A7	TS-000
[00040316]	Walk Test Disabled	walk test complete	O	(6) A7	TE-000
[00040316]	General System Trouble/Rest.	indicates one or more of following: PC4204/PC4204CX/PC4820/PC4702/PC4850***/ Alternate Communicator*** AC, battery and Aux Supply troubles/rest., PC440X troubles, automation fault, PC4164 RF jam <b>NOTE:</b> <i>When the system is being used in a fire applications, a General System trouble should be considered as a Fire trouble.</i>	O	(3) 3A	YX-000/YZ-000
[00040316]	General Device Low Battery/ Rest.	Wireless zones/pendants (WLS908) 009-128; handheld keypads (WLS910) wireless keys (WLS909)	O	(3) 84	XT/XR-ZZZ XT/XR-901-904 XT/XR-921-936
[00040316]	Gen Module Comm Fault/ Rest.	control panel loses communications with connected module(s)	O	(3) 33	ET-000/ER-000

\* A/R = alarms/restorals; O/C = openings/closings; O = other  
\*\* PPP = partition number; UUU = user number (user 1000 to 1500 = 999); ZZZ = zone number  
\*\*\* Not UL Listed. Do not use in conjunction with UL Listed systems

# Appendix B: Zone Reporting Codes

For notes on Contact ID and SIA reporting codes, see Appendix A.

Zone Definition	Contact ID Auto Rep Codes*			SIA Auto Rep Codes**		
	Zone Alm/Rest.	Zone Troub/Tam Alm/Rest.	Zone Fault/Rest.	Zone Alm/Rest.	Zone Troub/Tam Alm/Rest.	Zone Fault/Rest.
Standard Delay, Auxiliary Delay, Instant, Interior, Interior Delay, Interior Stay/Away, Delay Stay/Away	(1) 3A	(3) 83	(3) 8A	BA-ZZZ/BH-ZZZ	TA-ZZZ/TR-ZZZ	UT-ZZZ/UJ-ZZZ
Standard Fire, Delayed Fire, Auto Verify Fire	(1) 1A	(3) 73	(3) 73	FA-ZZZ/FR-ZZZ	FT-ZZZ/FJ-ZZZ	FT-ZZZ/FJ-ZZZ
Waterflow	(1) 13	(3) 73	(3) 73	SA-ZZZ/SH-ZZZ	ST-ZZZ/SJ-ZZZ	ST-ZZZ/SJ-ZZZ
Fire Supervisory	(2) AA	(3) 73	(3) 73	FS-ZZZ/FR-ZZZ	FT-ZZZ/FJ-ZZZ	FT-ZZZ/FJ-ZZZ
LINKS Supervisory	(3) 8A	(3) 8A	(3) 8A	US-ZZZ/UR-ZZZ	US-ZZZ/UR-ZZZ	US-ZZZ/UR-ZZZ
24Hr Bell, 24Hr Bell/Buzzer, 24Hr Buzzer	(1) 3A	(3) 83	(3) 8A	BA-ZZZ/BH-ZZZ	TA-ZZZ/TR-ZZZ	UT-ZZZ/UJ-ZZZ
24Hr Technical	(1) 5A	(3) 83	(3) 8A	UA-ZZZ/UH-ZZZ	TA-ZZZ/TR-ZZZ	UT-ZZZ/UJ-ZZZ
24Hr Gas	(1) 5A	(3) 83	(3) 8A	GA-ZZZ/GH-ZZZ	TA-ZZZ/TR-ZZZ	UT-ZZZ/UJ-ZZZ
24Hr Heat	(1) 5A	(3) 83	(3) 8A	KA-ZZZ/KH-ZZZ	TA-ZZZ/TR-ZZZ	UT-ZZZ/UJ-ZZZ
24Hr Medical	(1) AA	(3) 83	(3) 8A	MA-ZZZ/MH-ZZZ	TA-ZZZ/TR-ZZZ	UT-ZZZ/UJ-ZZZ
24Hr Emergency	(1) A1	(3) 83	(3) 8A	QA-ZZZ/QH-ZZZ	TA-ZZZ/TR-ZZZ	UT-ZZZ/UJ-ZZZ
24Hr Water	(1) 5A	(3) 83	(3) 8A	WA-ZZZ/WH-ZZZ	TA-ZZZ/TR-ZZZ	UT-ZZZ/UJ-ZZZ
24Hr Freeze	(1) 5A	(3) 83	(3) 8A	ZA-ZZZ/ZH-ZZZ	TA-ZZZ/TR-ZZZ	UT-ZZZ/UJ-ZZZ
24Hr Holdup	(1) 22	(3) 83	(3) 8A	HA-ZZZ/HH-ZZZ	TA-ZZZ/TR-ZZZ	UT-ZZZ/UJ-ZZZ
24Hr Panic	(1) 2A	(3) 83	(3) 8A	PA-ZZZ/PH-ZZZ	TA-ZZZ/TR-ZZZ	UT-ZZZ/UJ-ZZZ
Latching 24Hr	(1) 3A	(3) 83	(3) 8A	BA-ZZZ/BH-ZZZ	TA-ZZZ/TR-ZZZ	UT-ZZZ/UJ-ZZZ
Momentary Arm, Maintained Arm	n/a	n/a	n/a	n/a	n/a	n/a
Forced Answer	n/a	n/a	n/a	n/a	n/a	n/a
LINKS Answer	n/a	n/a	n/a	n/a	n/a	n/a
AC Delay	n/a	n/a	n/a	n/a	n/a	n/a

\* If Contact ID is used, the above reporting codes are suggested.

\*\* ZZZ = zones 001-128

**Suggested Contact ID Event Codes:** The numbers in brackets are not programmable. The two-digit number following the brackets is the programmable reporting code.

**Medical Alarms**  
 (1)AA Medical  
 (1)A1 Pendant Transmitter  
 (1)A2 Fail to Report In

**Fire Alarms**  
 (1)1A Fire Alarm  
 (1)11 Smoke  
 (1)12 Combustion  
 (1)13 Water Flow  
 (1)14 Heat  
 (1)15 Pull Station  
 (1)16 Duct

(1)17 Flame  
 (1)18 Near Alarm  
**Panic Alarms**  
 (1)2A Panic  
 (1)21 Duress  
 (1)22 Silent  
 (1)23 Audible

**Burglar Alarms**  
 (1)3A Burglary  
 (1)31 Perimeter  
 (1)32 Interior  
 (1)33 24 Hour

(1)34 Entry / Exit  
 (1)35 Day / Night  
 (1)36 Outdoor  
 (1)37 Tamper  
 (1)38 Near Alarm  
**General Alarms**  
 (1)4A General Alarm  
 (1)43 Exp. module failure  
 (1)44 Sensor tamper  
 (1)45 Module Tamper

**24 Hour Non-Burglary**  
 (1)5A 24 Hour non-Burg  
 (1)51 Gas detected  
 (1)52 Refrigeration  
 (1)53 Loss of Heat  
 (1)54 Water Leakage  
 (1)55 Foil Break  
 (1)56 Day Trouble  
 (1)57 Low bottled Gas level  
 (1)58 High Temp  
 (1)59 Low Temp  
 (1)61 Loss of Air Flow

# Appendix C: ASCII Characters

032	0	@	P	`	p	—	ˆ	≡	⊗	ρ	
	048	064	080	096	112	160	176	192	208	224	240
!	1	A	Q	a	q	•	ˆ	ˆ	ˆ	ˆ	
033	049	065	081	097	113	161	177	193	209	225	241
"	2	B	R	b	r	ˆ	ˆ	ˆ	ˆ	ˆ	
034	050	066	082	098	114	162	178	194	210	226	242
#	3	C	S	c	s	ˆ	ˆ	ˆ	ˆ	ˆ	
035	051	067	083	099	115	163	179	195	211	227	243
\$	4	D	T	d	t	`	I	ˆ	ˆ	ˆ	
036	052	068	084	100	116	164	180	196	212	228	244
%	5	E	U	e	u	•	ˆ	ˆ	ˆ	ˆ	
037	053	069	085	101	117	165	181	197	213	229	245
&	6	F	V	f	v	ˆ	ˆ	ˆ	ˆ	ˆ	
038	054	070	086	102	118	166	182	198	214	230	246
'	7	G	W	g	w	ˆ	ˆ	ˆ	ˆ	ˆ	
039	055	071	087	103	119	167	183	199	215	231	247
(	8	H	X	h	x	ˆ	ˆ	ˆ	ˆ	ˆ	
040	056	072	088	104	120	168	184	200	216	232	248
)	9	I	Y	i	y	ˆ	ˆ	ˆ	ˆ	ˆ	
041	057	073	089	105	121	169	185	201	217	233	249
*	:	J	Z	j	z	ˆ	ˆ	ˆ	ˆ	ˆ	
042	058	074	090	106	122	170	186	202	218	234	250
+	;	K	[	k	[	ˆ	ˆ	ˆ	ˆ	ˆ	
043	059	075	091	107	123	171	187	203	219	235	251
,	<	L	∗	l	l	ˆ	ˆ	ˆ	ˆ	ˆ	
044	060	076	092	108	124	172	188	204	220	236	252
—	=	M	]	m	]	ˆ	ˆ	ˆ	ˆ	ˆ	
045	061	077	093	109	125	173	189	205	221	237	253
•	>	N	^	n	→	ˆ	ˆ	ˆ	ˆ	ˆ	
046	062	078	094	110	126	174	190	206	222	238	254
/	?	O	_	o	←	ˆ	ˆ	ˆ	ˆ	ˆ	
047	063	079	095	111	127	175	191	207	223	239	255

# Index

- A**
  - Access Code
    - grand master 22
    - guard 26
    - options 26
    - second master 22
    - walk test 22
  - Access Levels 26
  - Account Number 13, 37
  - Addressable Loop
    - current 6
    - enrolling devices 12
    - moving devices 12
    - panel key 12
    - removing devices 12
    - response time 6
    - wiring 6
  - AML. *See* Addressable Loop
  - Arming
    - automatic 27
    - options 27
  - ASCII Characters 52
  - Audible Exit Fault 27
  - Automatic Arming 27
  - AUX
    - wiring 6
  - Auxiliary Key 19
  - Away 20
- B**
  - Battery
    - connection 7
    - selection 8
  - Bell Output
    - programming 33
    - wiring 7
  - Bell Squawk 27
  - Bell Supervision 29
- C**
  - Capacitance 4
  - Chime 10
  - Clock
    - adjust 30
    - options 29
    - set time and date 29
  - Combus
    - capacitance 4
    - current calculation 3
    - line loss 3
    - operation 3
  - Combus Repower 4
  - Communicator
    - formats 39
    - options 37
  - Contact ID 39
  - Cross Zone Alarm 32
  - Current Calculation
    - addressable loop 6
    - main panel 2
    - module 3
  - Current Rating
    - control panel 2
    - module 3
- D**
  - Daylight Savings 29
  - Default Panel 45
  - Delinquency 13
  - Diagnostics 45
  - Dialing
    - direction 39
    - options 37
    - parameters 37
  - Downloading 41
  - DTMF 37
- E**
  - Earth Ground Wiring 7
  - Enrolling
    - addressable devices 13
    - keypads 11
    - modules 11
  - Entry Delay 28
    - options 28
    - programming 13
    - times 28
  - Exit 20
  - Exit Delay 28
    - options 28
    - programming 13
    - times 28
- F**
  - F, A, P Keys 19
  - Factory Default
    - reset defaults 45
  - Fire Key 19
  - Function Key 20
- G**
  - Global Keypad 18
  - Global Zone 14
  - Ground. *See* Earth Ground
  - Guard Code
    - guard delay 26
    - guard duration 26
- H**
  - Hardware Reset 45
  - Help
    - user 21
  - Holiday Groups 42
- I**
  - Installer's Code 22
  - Interval Programming 42
- K**
  - Keypad
    - enrollment 11
    - global 18
    - options 19
    - partition 18
    - tamper 20
  - Keypad Blanking 19
  - Keypad Lockout 19
  - Keypad Time-out 19
  - Keyswitch 5
- L**
  - Labels
    - command output 35
    - partition 13
    - programming 14
    - zone 14
  - Line Loss 3
  - LINKS
    - cellular 44
    - long-range radio 44
    - options 44
    - zone wiring 5
- M**
  - Module
    - confirming 12
    - enrollment 11
    - tampers 11
  - Music input 21
- P**
  - Panel Key 12
  - Panic Key 19
  - Partition
    - account number 13
    - add new zone 14
    - creating 13
    - delete zone 14
    - edit zone 14
    - labels 13
    - times 13
    - toggle options 13
  - Partition Keypad 18
  - PC-Link 41
  - Periodic Call-up 41
  - PGM Output
    - addressable loop 12
    - options 33
    - programming 33
    - pulse times 35
    - wiring 5
  - Police Code. *See* Cross Zone Alarm
  - Postpone Arm 27
  - Power
    - 4204 4
    - AC 7
    - applying 7
    - auxiliary 6
    - battery 7
    - options 29
    - switched auxiliary 6
  - Power Supply 4
  - Programmable Output. *See* PGM Output
  - Programming
    - by reference number 9
    - decimal data 9
    - hexadecimal data 10
    - how to 9
    - toggle options 10
- R**
  - Reporting Codes
    - contact ID 48
    - programming 40
    - SIA 48
    - zone 51
  - Reset 20
- S**
  - SAUX+
    - wiring 6
  - Schedule
    - access levels 26
    - arm / disarm 43
    - date 42
    - holiday group 42
    - interval 42
    - open/close suppression 42
    - smoke test 43
  - SIA 40
  - Standard Time 29
  - Stay 20
  - Supervision
    - bell circuit 29
    - telephone line 31
    - zone 13
  - Swinger Shutdown 30
  - System Planning 2
- T**
  - Tamper
    - keypad 20
    - module enrollment 11
    - options 30
  - TCP/IP 44
  - Telephone
    - line wiring 7
    - numbers 37
    - supervision 31
  - Terminal Descriptions 2
  - Test Transmission 31
  - T-Link module 44
  - Toggle Options
    - communicator 37
    - how to program 10
    - partition 13
- U**
  - User help 21
- W**
  - Wiring
    - addressable loop 6
    - bell output 7
    - earth ground 7
    - PGM output 5
    - powered devices 6
    - telephone line 7
    - zones. *See* Zone Wiring
- Z**
  - Zone
    - attributes 17
    - global 14
    - programming 14
    - supervision 13
    - types 15
  - Zone Assignment 13
  - Zone control 21
  - Zone Expander 11
  - Zone Wiring
    - double end of line 4
    - fire zone 5
    - keyswitch 5
    - LINKS answer 5
    - LINKS supervisory 5
    - no end of line 4
    - single end of line 4

## UL Listed Commercial and Residential Installations

The installation requirements listed below must be met for the following grades of service.

*Note: All modules, keypads and enclosures used with this control panel must be UL Listed/Labeled.*

### Grade AA Central Station and Police Connect

The installation must use T-Link module which communicates over LAN/WAN to the Sur-Gard MLR-IP receiver. Polling time must be 90 seconds. Compromise detection time must be 6 minutes.

### Grade A Local

The installation must have a bell UL Listed for mecantile local alarms (AMSECO MBL10B with Model AB-12 bell housing).

The digital communicator must be enabled.

The control panel must be in the Attack Resistant Enclosure (UL Listed DSC models CMC-1, PC4004C, P/PC4050CAR or P/PC4050CRAR).

### Grade B Central Station and Grade A Police Connect

The installation must have a bell UL Listed for mecantile local alarms (AMSECO MBL10B with Ademco AB-12 bell housing).

The digital communicator must be enabled.

The control panel must be in the Attack Resistant Enclosure (UL Listed DSC models CMC-1, PC4004C, P/PC4050CAR or P/PC4050CRAR).

### Grade C Central Station

The digital communicator must be enabled.

The control panel must be in the Attack Resistant Enclosure (UL Listed DSC models CMC-1, PC4004C, P/PC4050CAR or P/PC4050CRAR).

### All Commercial Installations

- The entry delay must not exceed 60 seconds
- The exit delay must not exceed 60 seconds.
- The minimum bell cutoff time is 15 minutes.

### Residential Installations

- The entry delay must not exceed 45 seconds
- The exit delay must not exceed 60 seconds.
- The minimum bell cutoff time is 4 minutes.

### Programming

The notes in the programming sections describing the system configurations for UL Listed installations must be implemented including the following:

- The 'Quick Exit' feature must be disabled.
- The 'Bell Squawk on Trouble' feature must be enabled.
- The minimum 'Dialing Attempt' is five and maximum is ten.
- All Burglary-type zones should be configured with EOL configuration.
- The 'Code Required to Bypass zones' feature must be enabled.
- Select 'Bypass Status Not Displayed While Armed' option.
- 'Test Transmission Cycle' must be set for daily transmission.
- 'Temporal Three Fire Signal' must be enabled.
- Keypad Lockout' must be programmed.
- 'Closing Confirmation' must be enabled.
- 'Trouble Light Flashes If AC Fails' option must be enabled.

### Control of the Protected Premises

In order to have a UL Certificated system the protected area is to be under the responsibility of one ownership and management (i.e. one business under one name). This may be a group of buildings attached or unattached with different addresses but under the responsibility of someone having mutual interest. The person of mutual interest is not the alarm installing company.

### Bell Location

The alarm sounding device (bell) must be located where it can be heard by the person or persons responsible for maintaining the security system during the daily arming cycle.

### Protection of the Control Unit

The local control and the local power supply must be protected by one of the following ways:

- The control unit and audible alarm device must be in a protected area which is armed 24 hours a day.
- Each partition shall arm the area protecting the control unit and the audible alarm device power supply. This may require duplicate protection armed by each partition. Access to this protected area, without causing an alarm, will require that all partitions be disarmed.

In all cases described above, the protected area for the control unit must be programmed as not bypassable.

### User Information

The installer should advise the users and note in the user instruction manual:

- Service organization name and telephone number
- The programmed exit time
- The programmed entry time

### Commercial Fire Monitoring Installations

- Refer to Commercial Fire Installation Guide

## FCC COMPLIANCE STATEMENT

**CAUTION: Changes or modifications not expressly approved by Digital Security Controls Ltd. could void your authority to use this equipment.**

This equipment has been tested and found to comply with the limits for a Class B digital device, pursuant to Part 15 of the FCC Rules. These limits are designed to provide reasonable protection against harmful interference in a residential installation. This equipment generates, uses and can radiate radio frequency energy and, if not installed and used in accordance with the instructions, may cause harmful interference to radio communications. However, there is no guarantee that interference will not occur in a particular installation. If this equipment does cause harmful interference to radio or television reception, which can be determined by turning the equipment off and on, the user is encouraged to try to correct the interference by one or more of the following measures:

- Re-orient the receiving antenna.
- Increase the separation between the equipment and receiver.
- Connect the equipment into an outlet on a circuit different from that to which the receiver is connected.
- Consult the dealer or an experienced radio/television technician for help.

The user may find the following booklet prepared by the FCC useful: "How to Identify and Resolve Radio/Television Interference Problems". This booklet is available from the U.S. Government Printing Office, Washington D.C. 20402, Stock # 004-000-00345-4.

### IMPORTANT INFORMATION

This equipment complies with Part 68 of the FCC Rules. On the side of this equipment is a label that contains, among other information, the FCC registration number and ringer equivalence number (REN) for this equipment. If requested, this number must be provided to the Telephone Company.

FCC Registration Number: F53CAN-20836-AL-E

REN: 0.1B

USOC Jack: RJ-31X

### Telephone Connection Requirements

A plug and jack used to connect this equipment to the premises wiring and telephone network must comply with the applicable FCC Part 68 rules and requirements adopted by the ACTA. A compliant telephone cord and modular plug is provided with this product. It is designed to be connected to a compatible modular jack that is also compliant. See installation instructions for details.

### Ringer Equivalence Number (REN)

The REN is used to determine the number of devices that may be connected to a telephone line. Excessive RENs on a telephone line may result in the devices not ringing in response to an incoming call. In most but not all areas, the sum of RENs should not exceed five (5.0). To be certain of the number of devices that may be connected to a line, as determined by the total RENs, contact the local Telephone Company. For products approved after July 23, 2001, the REN for this product is part of the product identifier that has the format.

US: AAAEQ##TXXXX. The digits represented by ## are the REN without a decimal point (e.g., 03 is a REN of 0.3). For earlier products, the REN is separately shown on the label.

### Incidence of Harm

If this equipment PC4020 causes harm to the telephone network, the telephone company will notify you in advance that temporary discontinuance of service may be required. But if advance notice is not practical, the Telephone Company will notify the customer as soon as possible. Also, you will be advised of your right to file a complaint with the FCC if you believe it is necessary.

### Changes in Telephone Company Equipment or Facilities

The Telephone Company may make changes in its facilities, equipment, operations or procedures that could affect the operation of the equipment. If this happens the Telephone Company will provide advance notice in order for you to make necessary modifications to maintain uninterrupted service.

### Equipment Maintenance Facility

If trouble is experienced with this equipment PC4020, for repair or warranty information, please contact the facility indicated below. If the equipment is causing harm to the telephone network, the Telephone Company may request that you disconnect the equipment until the problem is solved. This equipment is of a type that is not intended to be repaired by the end user.

Simplex Time Recorder Co. 100 Simplex Drive, Westminister MA 01441-0001 USA,  
Tel: (978) 731-2500

### Additional Information

Connection to party line service is subject to state tariffs. Contact the state public utility commission, public service commission or corporation commission for information.

Alarm dialing equipment must be able to seize the telephone line and place a call in an emergency situation. It must be able to do this even if other equipment (telephone, answering system, computer modem, etc.) already has the telephone line in use. To do so, alarm dialing equipment must be connected to a properly installed RJ-31X jack that is electrically in series with and ahead of all other equipment attached to the same telephone line. Proper installation is depicted in the figure below. If you have any questions concerning these instructions, you should consult your telephone company or a qualified installer about installing the RJ-31X jack and alarm dialing equipment for you.

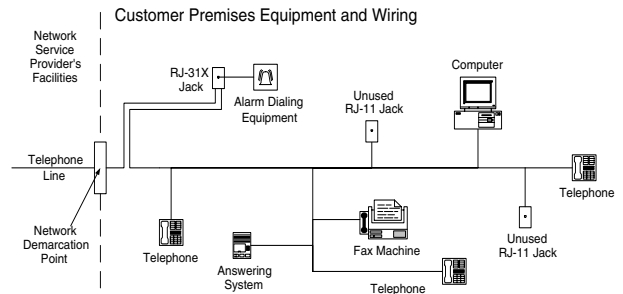

### **Changes for PC4020 v3.3**

The PC4020 v3.3 software incorporates several new features and changes. The most important additions are listed below:

#### **New Options & Features**

- Now has the ability to assign 128 addressable (AML) zones (*See Section 2.9 "AML Device Wiring" on page 5*).
- T-Link (TCP-IP) module support (*See Section 12.4 "Communicator Toggle Options" on page 37*).
- XSF card reader support (reader type 07).

